



InstaShow™

User Manual

VS20

V 1.00

Copyright

Copyright © 2023 by BenQ Corporation. All rights reserved. No part of this publication may be reproduced, transmitted, transcribed, stored in a retrieval system or translated into any language or computer language, in any form or by any means, electronic, mechanical, magnetic, optical, chemical, manual or otherwise, without the prior written permission of BenQ Corporation.

Disclaimer

BenQ Corporation makes no representations or warranties, either expressed or implied, with respect to the contents hereof and specifically disclaims any warranties, merchantability or fitness for any particular purpose. Further, BenQ Corporation reserves the right to revise this publication and to make changes from time to time in the contents hereof without obligation of BenQ Corporation to notify any person of such revision or changes.

This user manual aims to provide the most updated and accurate information to customers, and thus all contents may be modified from time to time without prior notice. Please visit www.BenQ.com for the latest version of this manual.

The illustrations and the images in this guide are for your reference.

Patents

Please go to <http://patmarking.benq.com/> for the details on BenQ projector patent coverage.

Statement regarding hyperlinks and third-party websites

BenQ is not responsible for the content of the websites or of similar resources, which are maintained and controlled by third parties, that may be linked from this product. Providing links to those websites or to similar resources does not mean that BenQ makes any warranty or representation to their content by expression or by implication.

Any third party content or service preinstalled in this product is provided "as is". BenQ does not, by expression or by implication, make any warrant to the content or to the services provided by third parties. BenQ does not warrant or guarantee that the content or services provided by third parties are accurate, effective, most up-to-date, legal, or complete. Under no circumstances shall BenQ be liable for the content or services provided by third parties including their negligence. Services provided by third parties may be terminated temporarily or permanently. BenQ does not warrant or guarantee that the any content or services provided by third parties are in good condition at any time, and is not liable for the termination of the said content and services. In addition, BenQ is not involved in any transactions you conduct in the websites or similar resources maintained by third parties.

You should contact the content or service providers for any questions, concerns, or disputes.

BenQ ecoFACTS

BenQ has been dedicated to the design and development of greener product as part of its aspiration to realize the ideal of the “Bringing Enjoyment 'N Quality to Life” corporate vision with the ultimate goal to achieve a low-carbon society. Besides meeting international regulatory requirement and standards pertaining to environmental management, BenQ has spared no efforts in pushing our initiatives further to incorporate life cycle design in the aspects of material selection, manufacturing, packaging, transportation, using and disposal of the products. BenQ ecoFACTS label lists key eco-friendly design highlights of each product, hoping to ensure that consumers make informed green choices at purchase. Check out BenQ's CSR Website at <http://csr.BenQ.com/> for more details on BenQ's environmental commitments and achievements.



Table of Contents

Copyright	2
Disclaimer.....	2
Patents.....	2
Statement regarding hyperlinks and third-party websites	2
BenQ ecoFACTS	3
Introduction	6
Product features	7
Package content.....	8
Product specifications	9
Overview.....	11
Button.....	11
Host.....	11
LED indicators of the Button and the Host	12
Installation.....	14
Environment check.....	14
Assembling the Host.....	15
Setting up the Host.....	15
Attaching the Host to the ceiling.....	15
Attaching the Host to a ceiling mount	16
Placing the Host on a table	16
Positioning the Host antennas	19
For ceiling installation.....	19
For ceiling mount installation	19
For table placement	20
Connecting the HDMI cable and power	21
Assembling the adapter.....	21
Connecting the HDMI cable.....	22
Power supply via a power adapter	22
LAN connection.....	23
Wi-Fi connection.....	23
Switching to the Button HDMI cable	24
Setting up and powering a Button	25
Pairing a Button and Host.....	28
When the Host is placed on a table	28
Storing Buttons and USB cable in the cradle	30
Resetting a Host	31
Resetting a Button	32
Enabling network standby mode	33
Starting and stopping presentations	34
Getting ready.....	34
Starting presentation.....	34
Idle presentation.....	35
Split screen presentations	36
Starting a split screen presentation.....	36
Switching from a split screen to a full screen presentation.....	37
Presenting with mobile devices.....	37
Touch back.....	38
Using InstaShow in hybrid meetings	39
Setting up a videoconference	39
Using an external webcam	43

Using a single InstaShow Button as a microphone.....	45
Using multiple InstaShow Buttons as microphones	46
Connecting another WPS to the Host	47
Web management.....	48
Accessing the web management interface	48
Logging into the web management interface via direct connection	48
Logging into the web management interface via LAN	51
Logging into the web management interface via a wireless network	51
Getting started.....	53
Top command buttons	53
Main column.....	53
Information.....	54
WAN.....	56
Wireless Network.....	57
Peripheral Setting.....	60
Pairing.....	63
Display	65
Advance Setting	66
Scheduling	68
Tools	69
Legal Announcement.....	81
Troubleshooting	82
Error code	84

Introduction

Instashow VS20 is a wireless conferencing solution that supports BYOM in your organization. You can use your own device to host a video conference. All you have to do is make a few clicks on your VS Assist App. Your presenters can use the VS20 buttons to share a presentation via simple plug-and-play. A dedicated microphone is built into each Instashow VS20 button. Whether the presenters are seated at a table, sitting against the wall, or standing, the VS20 button mic means everyone will be heard.

A standard product set consists of an InstaShow™ VS20 Host (or “Host” in this document) and two InstaShow™ VS20 Buttons (or “Buttons” in this document). Depending on the location where you buy the product, the software of the base unit can be different. You can buy additional InstaShow™ VS20 Button kits if needed.

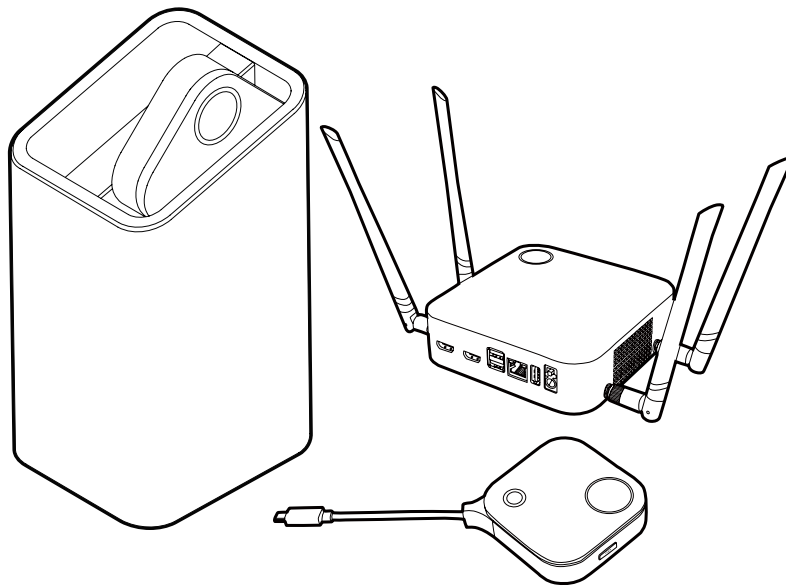

- "InstaShow™" will hereinafter be referred to as "the product" in this document.
- "InstaShow™ Host" will hereinafter be referred to as "Host" in this document.
- "InstaShow™ Button/Buttons" will hereinafter be referred to as "Button"/"Buttons" in this document.



Your product complies with the local wireless regulations and the warranties are valid in the country/region where the product is purchased. Using the product outside the purchased country/region does not guarantee the wireless functionalities. And modification of any part of the product will void the warranties.

The InstaShow™ is considered networked equipment with high network availability (HiNA equipment with HiNA functionality) as it provides wireless network access for wireless InstaShow™ Buttons. The detailed operations of standby please refer to [Enabling network standby mode on page 33](#) for more information.

Product features

The product is equipped with the following features:

Features	Description
Router based WIFI	Brings a stable Wi-Fi connection and security features that benefit the system.
Auto Channel Selection	The product automatically selects the best wireless channel upon bootup, ensuring smooth presentations in any environment.
Wireless Conferencing	
InstaShow Button Microphone for a wireless extendable mic system	Lightly equipped meeting rooms with a VS20 mic set will have a clear and uniform voice quality from any corner in the room.
USB ports	Connect VC devices and join meeting via cloud.
Wireless Presentation	
True Plug & Play	Simply connect the product into your USB-C port (or USB-A and HDMI ports), then press the Button to start presenting immediately.
No Software	The product doesn't need any software installation or execution. There's no setup, configuration, or waiting for pop-ups to launch. Just plug into your PC or Mac and start presenting immediately.
Split Screen Presentations	Up to four users can simultaneously project their screen via the product in a dual-screen, 3-way, or 4-way split screen configuration, so that you can view and reference multiple documents/videos at the same time during your presentation.
Touch Back	When the Host is connected to a touchscreen display via its USB ports, you can use the touchscreen to control the screen of the PC that is presenting, allowing you to actively engage with the content that is being presented.
Screen Casting for Mobile Devices	Project your mobile device's screen wirelessly via the screencasting capabilities of your mobile device.
Video and Audio	The product's HDMI output supports up to 60Hz DCI 4K video and stereo sound without cable clutter or complicated driver selection.
Assured Performance	Peace of mind for consistent wireless presentation performance without relying on your PC.
Extended Desktop	Keep your presenter view, notes, and backup data on your laptop screen while presenting to the wireless screen with extended desktop in both Windows and OS X.



- Touch back via USB port is only supported for Windows-based PCs. Macs and mobile devices cannot be controlled via touch screens.
- Transmission distance depends on actual environment. Stated distance is based on line-of-sight measurement. Structures constructed of steel, wood, concrete, or brick may decrease transmission distance.
- According to regulatory restrictions in different regions of the world, Wi-Fi channels cannot be used in countries outside the purchased region.

Package content

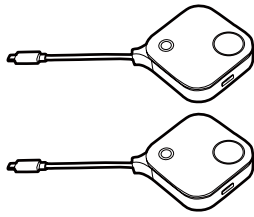

InstaShow™ Buttons

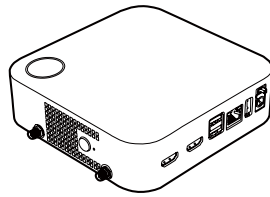

InstaShow™ Host

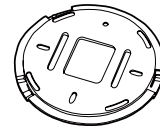

Lid

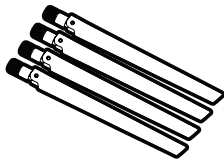

4 Antennas

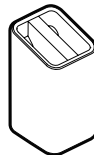

Cradle

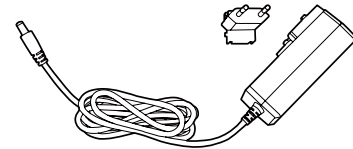

Adapter & Plugs

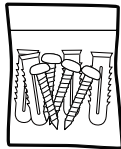

Screws and Screw Anchors

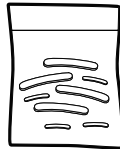

Rubber Feet

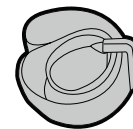

Velcro Strap

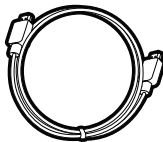

Cable: HDMI A(M) to A(M)

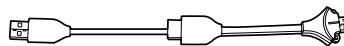

Button HDMI Cable

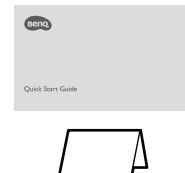

Quick Start Guide & Safety Statement



- The plug provided with the adapter will vary by region.
- Available accessories and the pictures shown here may differ from the actual contents and the product supplied for your region.
- Use original accessories to ensure compatibility.
- Always keep the product and accessories out of reach of children.

Product specifications

General Features	
Model name	VS20
Color	Black
Interface	HDMI In + HDMI Out + 2 x USB 3.0 (Type-A) + RJ45 (Ethernet) + 1 x USB 2.0 (Type-A)
Host HDMI-output resolution	HDMI 2.0 (Comply with HDCP 1.4): 4096x2160P60, 4096x2160P50, 4096x2160P24, 3840x2160P60, 3840x2160P50, 3840x2160P24, 1920x1200P60, 1920x1080P60, 1920x1080P50, 1920x1080P30, 1920x1080P24, 720x480P60
Host HDMI-input resolution	HDMI 1.4 (Comply with HDCP 1.4): 1920x1080P60, 1920x1080P50, 1920x1080P30, 1920x1080P24, 1280x720P60, 1280x720P50, 720x480P60, 640x480P60, 720x576P50
Mode	Split screen mode(on/off)
Simultaneous connections	32 pcs
Wi-Fi standard	IEEE 802.11ac, 5GHz, 2T2R IEEE 802.11n, 2.4GHz 5GHz, 2T2R
Maximum data rate	Up to 867Mbps + 300Mbps (at 5GHz + 2.4GHz at 802.11n)
Frequency band	2.4GHz, 5GHz
WiFi authentication	WPA2 (WPA2-PSK (Pre-Shared key) (AES128bit) / WPA2 enterprise (AES256bit)
WAN	1Gbps
Support platform	Windows, Linux, MAC, Chrome
Supported mobile display	<ul style="list-style-type: none"> • Supporting IOS wireless communication • Supporting Windows wireless communication
Temperature range	Operating: 0°C to +40°C (+32°F to +104°F)
	Storage: -10°C to +60°C (+14°F to +140°F)
Humidity	Storage: 5% to 90% relative humidity, non-condensing
	Operation: 10% to 80% relative humidity, non-condensing
Environmental	
Reach distance	Up to 20m**
Power consumption	Receiver: 11W/36W (Typical/Max)
Standby power consumption	<0.5W
Weight(Net)	530g
Temperature range	Operating: 0°C to +40°C (+32°F to +104°F)
	Storage: -10°C to +60°C (+14°F to +140°F)
Humidity	Storage: 5% to 90% relative humidity, non-condensing
	Operation: 10% to 80% relative humidity, non-condensing

InstaShow™ Button			
Cable	USB Type C	Power supply	DC 5V±10%, 0.9A
Reset button	x1	LED	Red/Green/Blue/White*
Present key	x1	Dimension (WxDxH)	85 x 106 x 24.5mm
Split Screen key	x1 (Share with Pairing Key)	Weight	95g
Power consumption	Up to 4.5W / 3.8W (Operating) / 2.8W (Standby)		
Wireless transmission protocol	IEEE 802.11 ac, 5GHz, 2T2R		
Data rate wireless	Up to 867Mbps (at 5GHz for 802.11ac)		
Frequency Band	5GHz		
InstaShow™ Host			
Standby button	x1	RJ45	x1
Power button	x1	Kensington lock	x1
Power DC jack	x1	USB	USB (Touch back): x1 (USB Type-A) USB (Camera & Speaker): x2 (USB Type-A)
Noise Level	Normal: 26dBA	Video	HDMI 2.0 output: x1 HDMI 1.4 input: x1
LED	Red/Green/Blue/White*	Power supply	DC 12V±10%, 3A
Dimension (WxDxH)	145 x 145 x 46mm	Power consumption	Receiver: 11W/36W (Typical/Max)
Weight	332g		
Cradle			
Dimension (WxDxH)	85 x 97.5 x 170.4mm	Weight	630g
Package contents			
InstaShow Button	x2	Velcro Strap	x1
InstaShow Host	x1	Quick Start Guide	x1
Cradle	x1	Safety Statement	x1
HDMI Cable	x1	Screws	Yes
Antenna	x4 (Black)	Power Adapter	x1
Tx Spare HDMI Cable	x1		



* See [LED indicators of the Button and the Host on page 12](#) for more information on LED behavior.

** Wireless connection speed and available maximum range depends on wireless environment.

Overview

Button

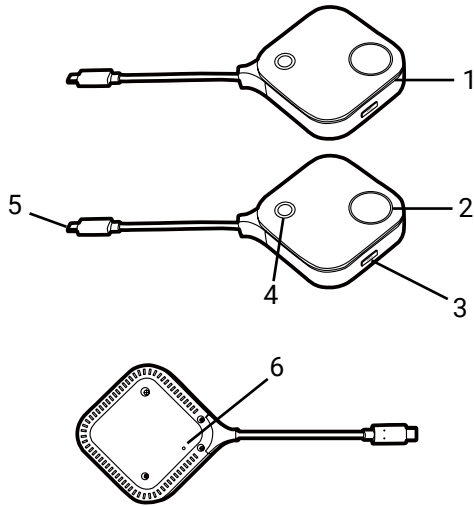

Bottom of a Button

- 1. Microphone**
Captures sound for videoconferences.
- 2. Present key with LED indicator**
Press to start or stop presenting.
- 3. Split screen key**
Press to enable split screen presentations.
- 4. Mute key**
Press to mute the microphone on the Button when it is used in a videoconference.
- 5. USB-C connector**
Connect to a computer or laptop.
- 6. Reset**
Poke the reset hole to reset the device if the device stops responding. Refer to [Resetting a Button on page 32](#) for more information.

Host

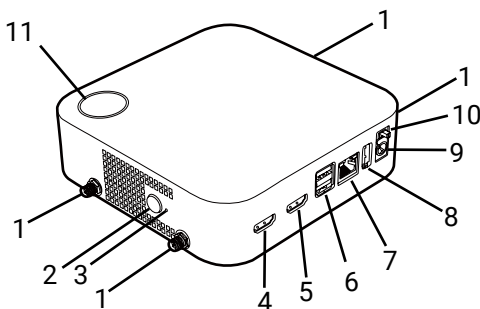

- 1. Fixture parts for the Antennas**
Refer to [Assembling the Host on page 15](#) for more information.
- 2. PAIRING key**
Press to pair with a Button.
- 3. RESET**
Poke the **RESET** hole to reset the device if the device stops responding. Refer to [Resetting a Host on page 31](#) for more information.
- 4. HDMI IN port**
Allows users to connect another Wireless Presentation System using an HDMI A(M) to A(M) cable to integrate it into a video conference.
- 5. HDMI OUT port**
Connect to a display using an HDMI A(M) to A(M) cable.

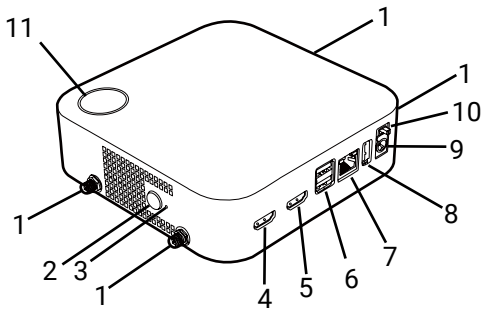

12 Lid of the Host

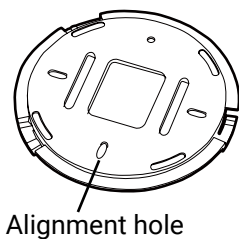

6. USB 3.0 ports

Connect to a webcam, microphone, and/or speakers for video conferencing.

7. WAN port

Allows the following connections:

- Connect the Host to a network for Internet access.
- Connect the Host to a laptop to access the Host's web management interface.

8. TOUCH SCREEN USB 2.0 port

Connect a touchscreen display to control the screen of the presenter's device via touch gestures.

9. DC 3A port

Connect to the supplied adapter extender power cable and adapter to power the Host.

10. Power switch

Slide to power on or off the Host.

11. Standby button with LED indicator

Press to turn the Host on and off.

12. Lid

Refer to [Attaching the Host to the ceiling on page 15](#) for more information.

LED indicators of the Button and the Host

Please refer to the tables below for detailed indicator and status descriptions for the Button and the Host.

LED indicator on the Button	Status Description
Static blue	The device is presenting.
Flashing blue	The device is pairing.
Flashing green	<ul style="list-style-type: none"> • The device is starting up and connecting to the Host. • The device is downloading the firmware.
Static green	The device is in standby mode and working normally.
Flashing red	The device is unable to connect to a Host.
Off	The device is powered off.
Quick flashing green	The device is upgrading the firmware.
Static white	The device is powering up.

LED indicator for the mute key on the Button	Status Description
Off	The microphone is enabled and unmuted.
Static red	The microphone is disabled and muted.

LED indicator on the Host	Status Description
Static blue	The connected device is presenting.
Flashing blue	The device is pairing.
Flashing green	<ul style="list-style-type: none"> • The device is starting up. • The device is upgrading the firmware.
Static white	<ul style="list-style-type: none"> • The device is powering up. • The device is in network standby mode.
Static green	The device is ready for presenting.
Off	The device is powered off.

Installation

This section will guide you on how to prepare the unit before its initial use.

Environment check

Before installing your InstaShow™ kit, check the environmental conditions.

1. Do not install the device near heat sources like radiators or direct sunlight, or in a site with excessive dust or humidity.
2. Ambient temperature conditions are listed as below. Maximum ambient temperature should be +40°C or 104°F. Minimum ambient temperature should be +0°C or 32°F. Storage temperature should be -10°C to +60°C (14°F to 140°F).
3. Humidity conditions are listed as below. For storage, the relative humidity should be 5% to 90% (non-condensing). For operation, the relative humidity should be 10% to 80% (non-condensing).

As the product works with different displays, the steps required to complete the installation may vary according to the actual environment and your display specifications. Follow the procedures below and refer to the specified sections for details.

1. Assemble the Host with the antennas. See [Assembling the Host on page 15](#) for details.
2. Connect the Host to the display and power properly. See [Connecting the HDMI cable and power on page 21](#) for details. Four installation methods are provided.
 - Attaching the Host to the ceiling
 - Attaching the Host to a ceiling mount
 - Placing the Host on a table
 - Installing the Host on the wall or trolley
3. Connect the Buttons to the desired devices and power properly. See [Setting up and powering a Button on page 25](#) for details.
4. Make sure that all the connected devices have been powered on. Press the source button of the display and make sure that the HDMI source has been transmitted. See [Pairing a Button and Host on page 28](#) for details.

Assembling the Host

Assemble the Host with four antennas by turning the antennas clockwise to fasten them tightly.

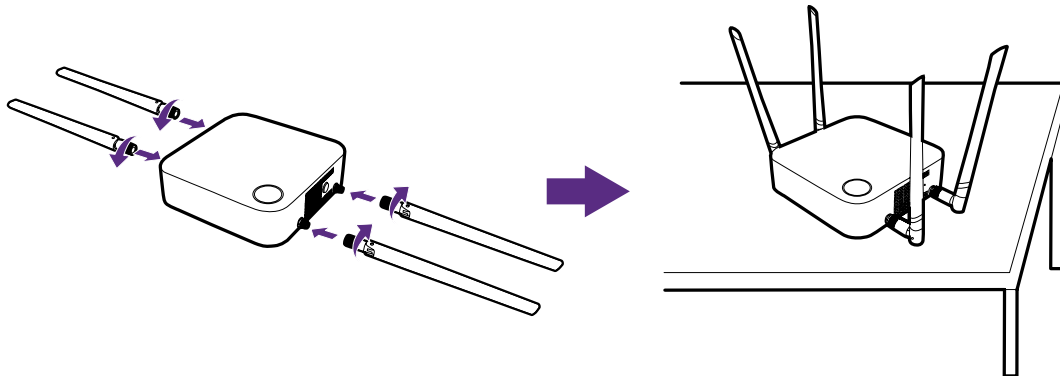

Setting up the Host

You are provided with four different ways to position the Host. The total weight of the Host Unit is 530g.

Attaching the Host to the ceiling

1. Place the lid on the ceiling and locate the alignment hole.
2. Use the screw anchors and screws provided to lock the lid to the ceiling.
3. Lock the first hole (1).
4. Follow the instruction in the illustration below to lock the other holes (2-4).
5. Rotate the Host counterclockwise to affix the Host to the lid.

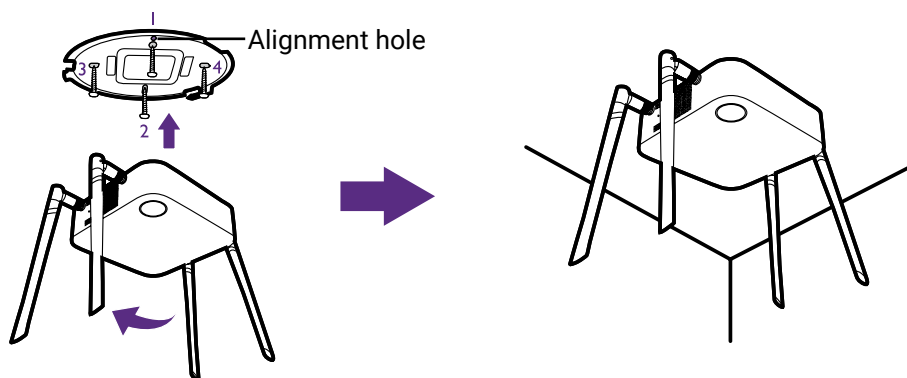

- Please only use the screws (M3*16 tapping screw) and screw anchors provided with the kit to mount the Host to the ceiling.
- Please see [Positioning the Host antennas on page 19](#) for guidelines on positioning the antenna to maximize signal reception.

Attaching the Host to a ceiling mount

If the display is mounted on the ceiling:

1. Attach the Host to the ceiling mount using the provided velcro strap.
2. Fix the Host to the mounting holder.
3. Use the supplied velcro to fix the mounting holder and the Host to the ceiling mount as shown in the illustration.

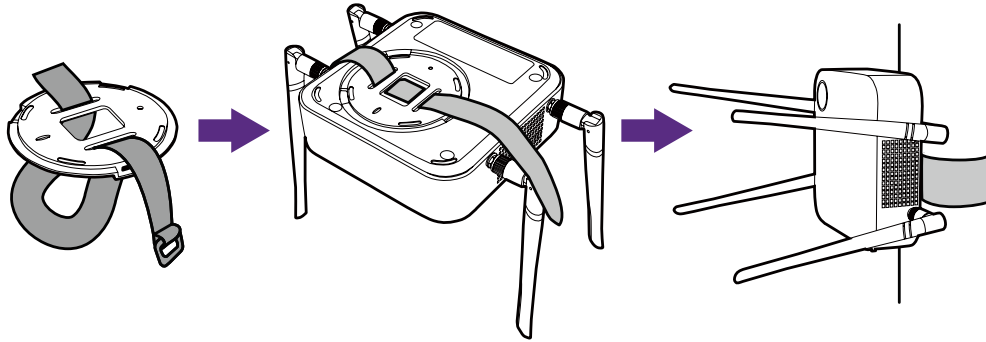

- Please only use the velcro strap (300(L)mm*25(W)mm) provided with the kit to mount the Host to a ceiling mount.
- Please see [Positioning the Host antennas on page 19](#) for guidelines on positioning the antenna to maximize signal reception.

Placing the Host on a table

If your display is placed on a table, first attach the lid to the Host by following the process described below:

1. Align the lid over the bottom of Host, then insert the lid into the lid compartment.

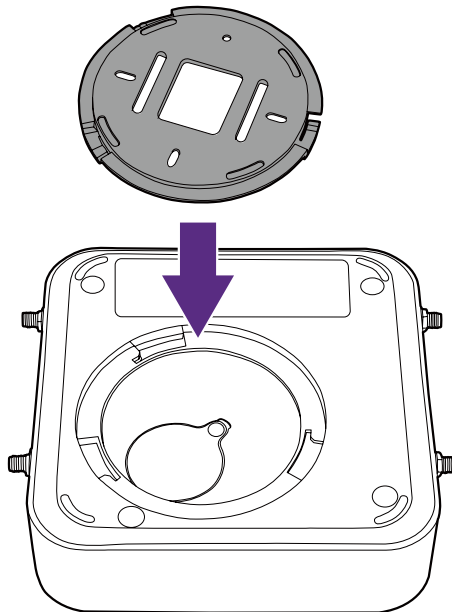

2. Turn the lid counter-clockwise until it clicks into place.

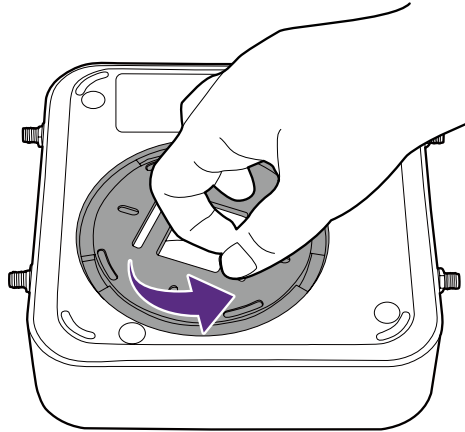

3. When the lid is correctly installed on the Host the alignment hole on the lid should be pointed to the front side of the Host.

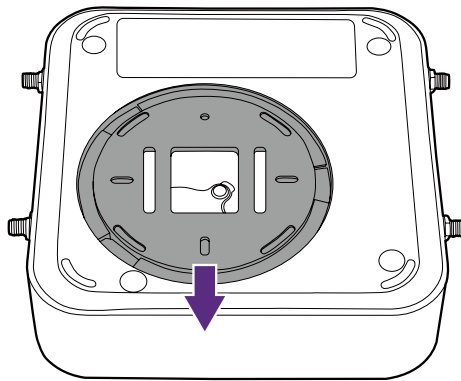

4. Attach the rubber feet to the recesses on the base of the Host and put the Host right next to the display.

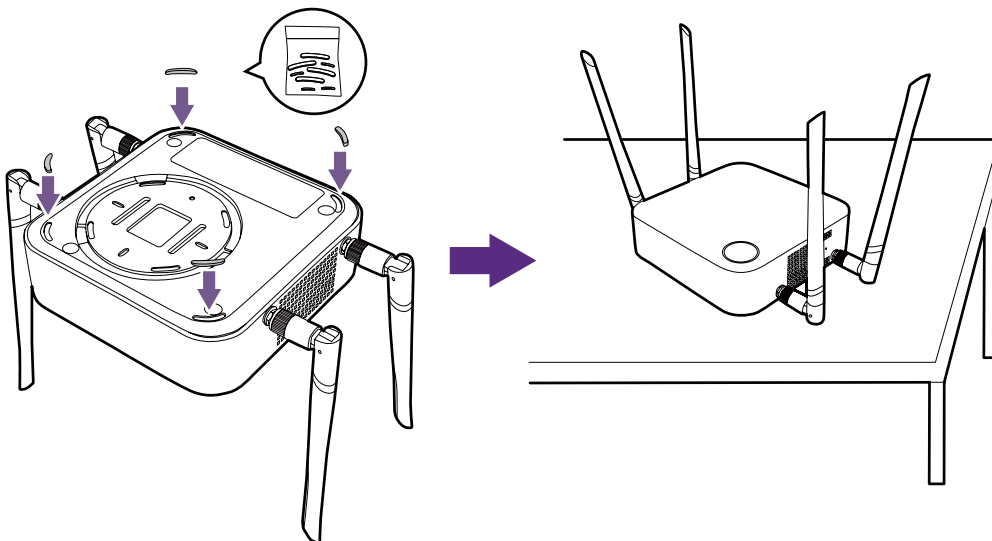

- Please only use the rubber foot provided with the kit to attach to the Host.
- Please see [Positioning the Host antennas on page 19](#) for guidelines on positioning the antenna to maximize signal reception.

You can also place the Host on a mobile display trolley. See the illustration.

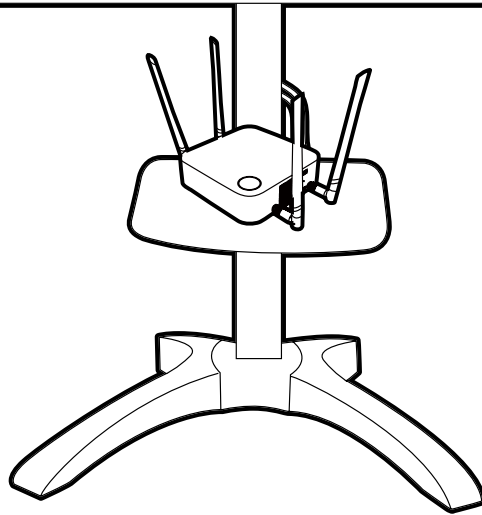

Positioning the Host antennas

Once you have properly installed the Host, follow the guidelines below to position the antennas to maximize signal reception:

For ceiling installation

Position the antennas so that they are both pointed downwards at an angle roughly perpendicular to the ceiling:

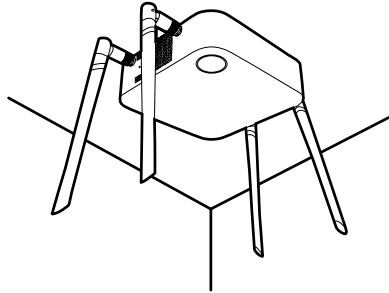

For ceiling mount installation

- Position the antennas so that they are both pointing either upwards or downwards roughly parallel to the ceiling mount:

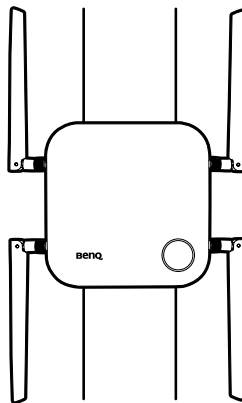

- If you encounter bad signal reception after initial use of the Host you can manually adjust the antennas so that they tilt at a slight angle to maximize signal reception. When doing so, avoid tilting the antennas toward the ceiling mount:

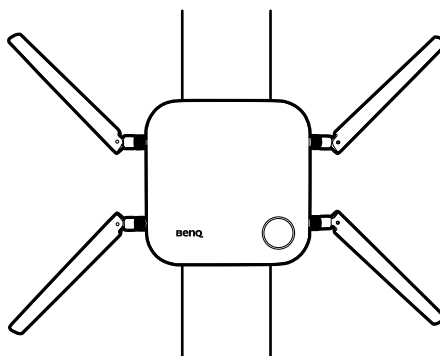

- Avoid positioning the antennas in a horizontal manner, this may result in a weak signal reception:

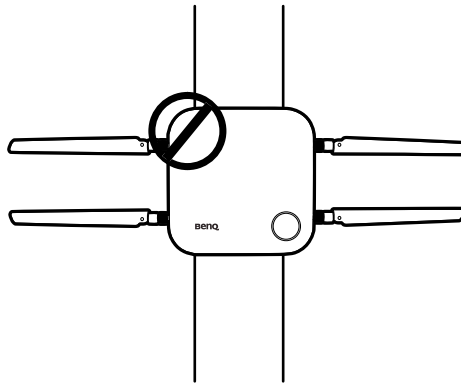

- If the Host is attached to a metallic ceiling mount ensure that the antennas are at least 3 cm away from the metal portion of the ceiling mount:

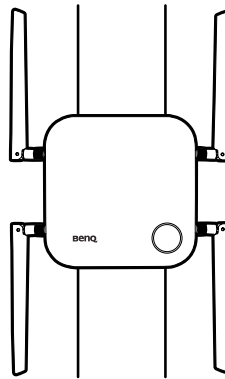

For table placement

Position the antennas so that they are both pointed upwards roughly perpendicular to the table:

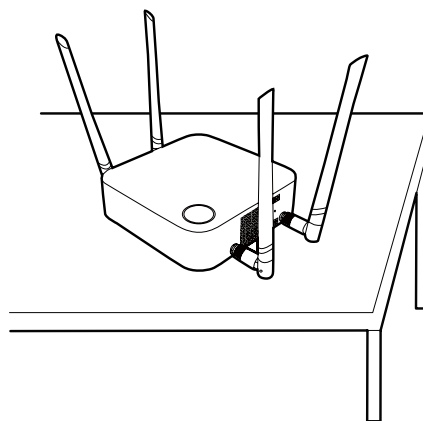

Connecting the HDMI cable and power

Once the Host has been positioned properly near the display, connect the HDMI cable and power to ensure signal transmission.

Assembling the adapter

Every adapter provided in the box includes a plug socket and plugs based on the region in which you purchased the product.

To connect the plug, follow the steps below.

1. Align and insert the plug into the adapter.
2. Push the plug all the way in until it clips into place.

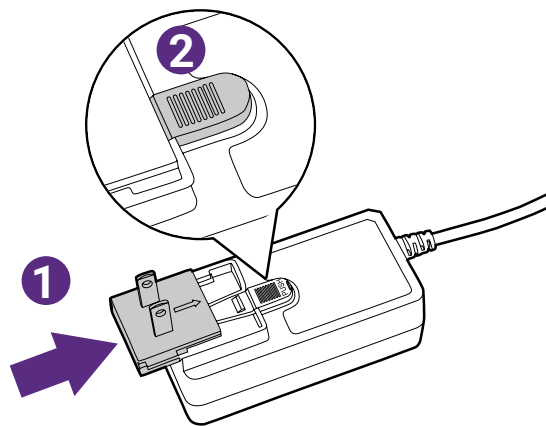

To disconnect the plug, follow the steps below.

1. Push the latch in the middle.
2. Detach the plug by pushing it outward and remove the plug.

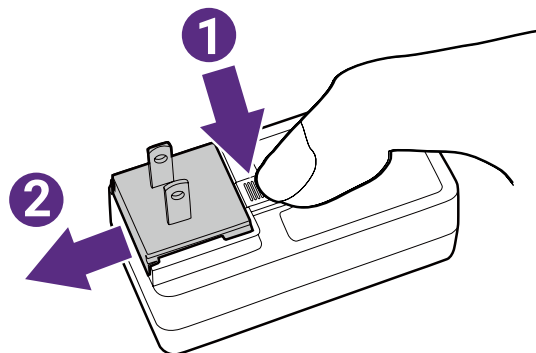

Connecting the HDMI cable

Connect the HDMI cable to the HDMI out jack of the Host and the HDMI input jack of the projector.

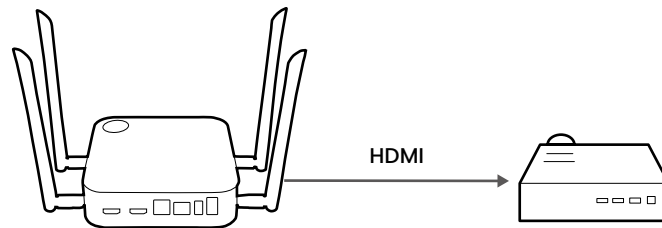

Power supply via a power adapter

Connect the supplied power adapter to the power jack of the Host, and then plug the other end of the power adapter into a wall socket and then turn on the power switch on the Host. The LED indicator on the standby button of the Host lights up static green when the power is supplied.

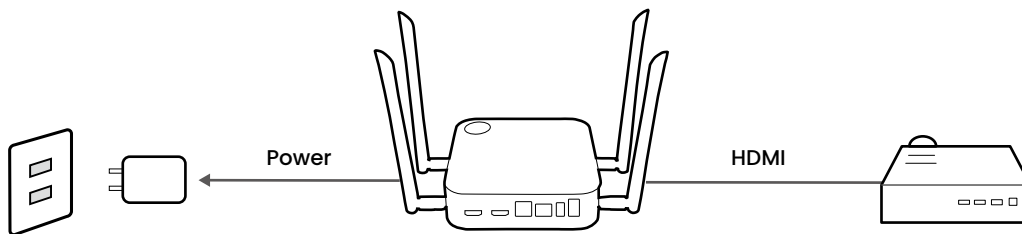

For BenQ IFP (Interactive Flat Panel) products, please have power supplied via a power adapter.



Do not keep the device powered on all the time. For better performance, power off the device for 30 minutes every 24 hours then restart it.

LAN connection

The Host can be connected to a local network or a laptop via its **WAN** port. The LAN connection can be used to:

- Access the Internet for videoconferences, see [Using InstaShow in hybrid meetings on page 39](#) for more information.
- Configure your product, see [Web management on page 48](#) for more information.
- Update the firmware, see [Firmware Upgrade on page 70](#) for more information.

Insert a network cable with RJ-45 connectors into the **WAN** port and connect the other side to a LAN.

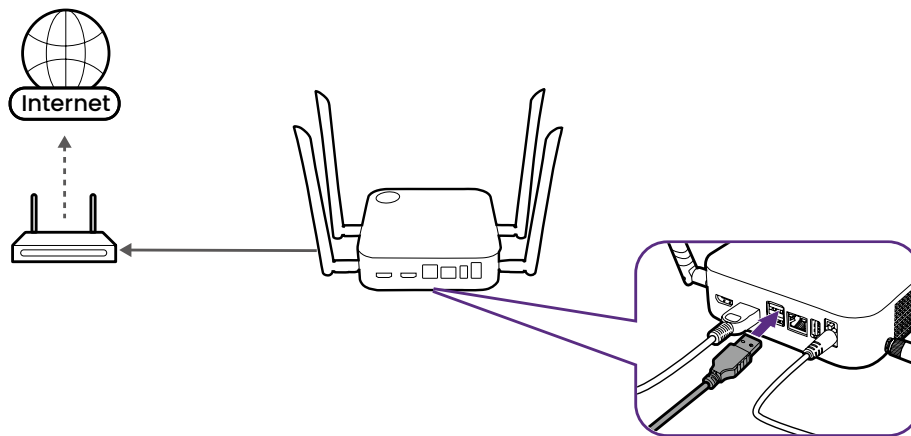

Wi-Fi connection

The host can also be connected to a network via a Wi-Fi connection. To connect to a Wi-Fi network:

1. Log into the web management menu using the steps described in [Accessing the web management interface on page 48](#).
2. Click the **WAN** menu in the web management menu.
3. In the **WAN Connection Type** field, select **Repeater**.
4. In the **SSID** field, enter the SSID of the Wi-Fi access point you want the Host to connect to.
5. In the **Security Mode** field select either **Open** or **WPA/WPA2 Mixed** for the type of security you want for the Wi-Fi connection.
6. In the **Password Setting** field enter the password for the Wi-Fi access point you want the Host to connect to.
7. In the **Frequency** field select the frequency of the Wi-Fi access point you want the Host to connect to.
8. Select **Apply** at the bottom of the menu.

Switching to the Button HDMI cable

A product set includes an additional Button HDMI cable which can be installed onto a Button to allow it to work with laptops without a USB-C port. To switch the cable on the Button to the HDMI cable, follow the steps below:

1. Remove the two screws on the bottom side of the Button adjacent to the USB-C cable.
2. Pull the plastic end of the USB-C cable to remove it from the Button.

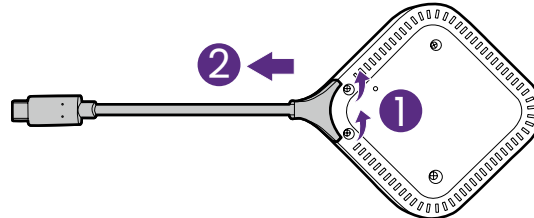

3. Push the HDMI cable into the compartment on the Button so that the connectors on the cable are inserted into the corresponding connectors on the Button.
4. Re-install the two screws on the bottom side of the Button.

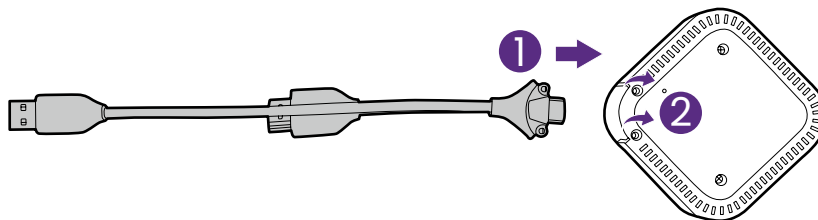

Setting up and powering a Button

1. Connect the button to a laptop using one of the following methods:

- Connect the Button's USB-C connector to the corresponding input of a laptop.

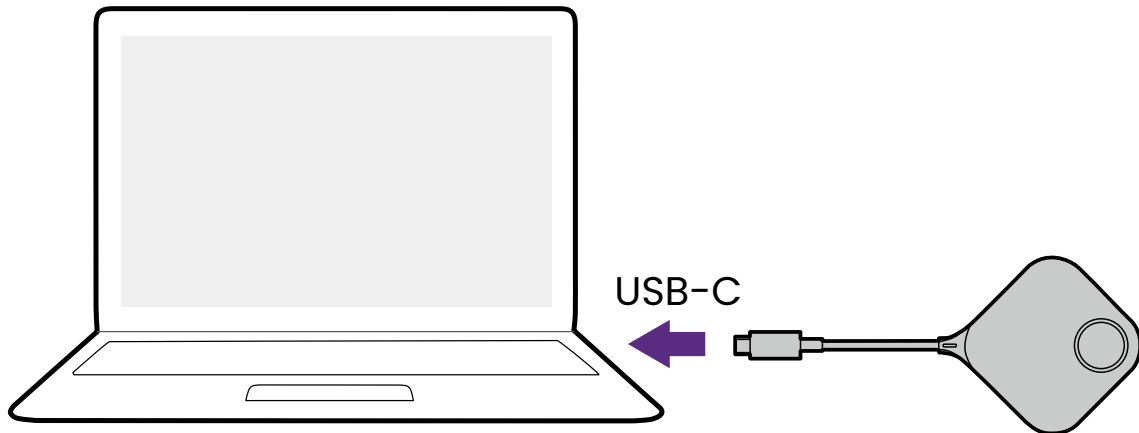

- For Buttons where the connectors have been switched to the HDMI cable, connect the Button's HDMI and USB connectors to the corresponding inputs of a laptop.

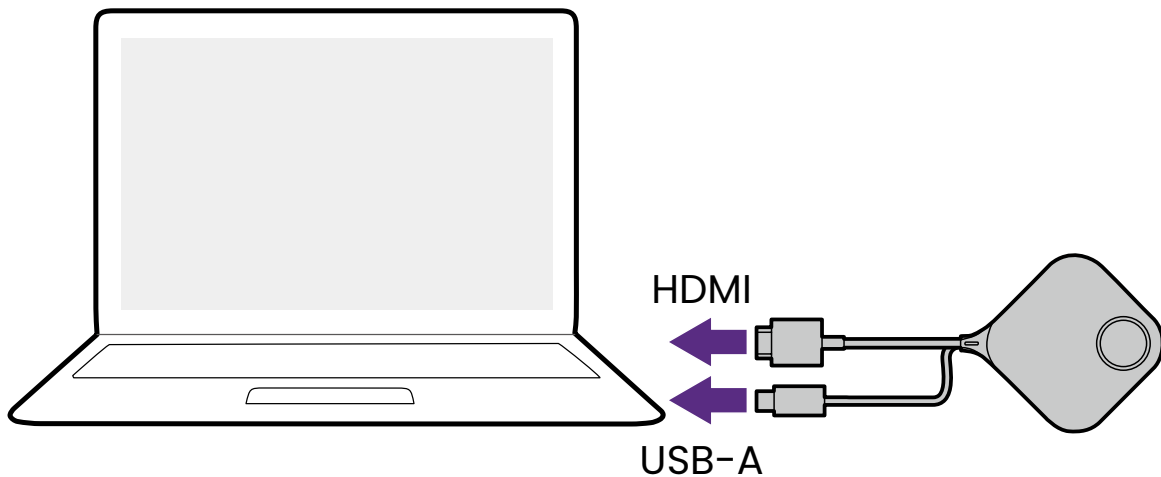

• For instructions on how to switch to the HDMI and USB-A cable for the Button, see [Switching to the Button HDMI cable on page 24](#).

• From hereinafter the images and text will only feature a Button using the default USB-C cable.

2. The LED indicator of the Button will flash green while the Button is starting up.

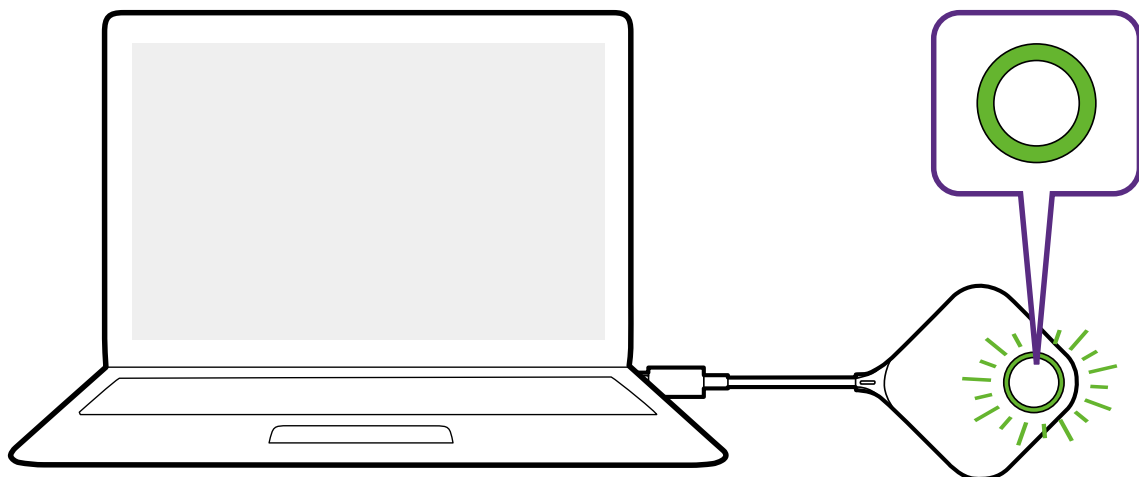

3. When the Button is ready to present, the LED indicator will turn solid green. Press the Present key when the LED indicator turns green.

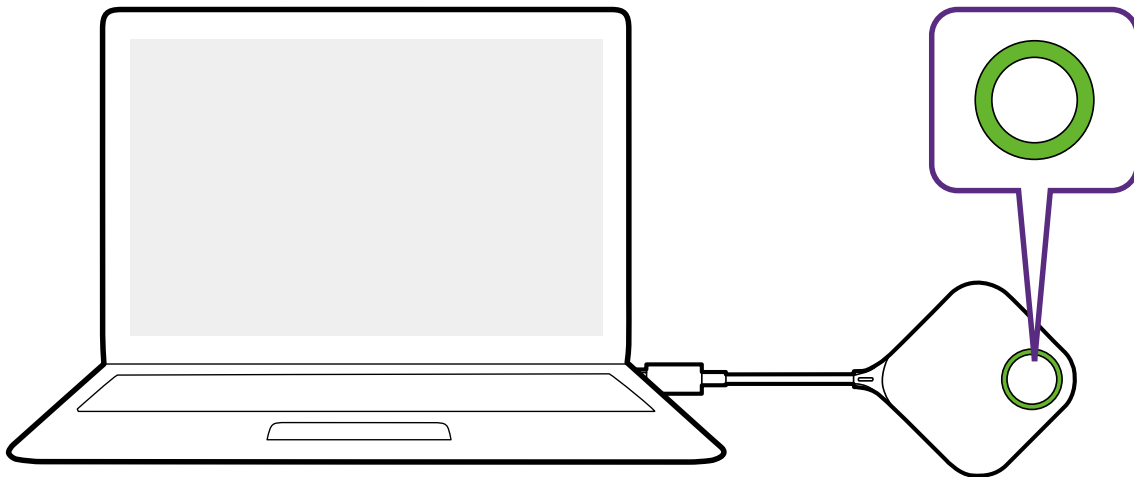

- If the Button encounters problems while pairing with the Host during startup, the LED indicator will flash red. Repeat the previous process again until the LED turns solid green. See [LED indicators of the Button and the Host on page 12](#) for more information on LED behavior.
- Handle the Button cable with care. Rough handling might cause defects.
- Pull/Push the connectors instead of the cable when inserting or removing Buttons.

If you purchase an additional Button (via a Button Kit), please follow the process described below:

1. Follow the pairing instructions described in [Pairing a Button and Host on page 28](#).
2. Connect the Button to the corresponding input of a laptop.

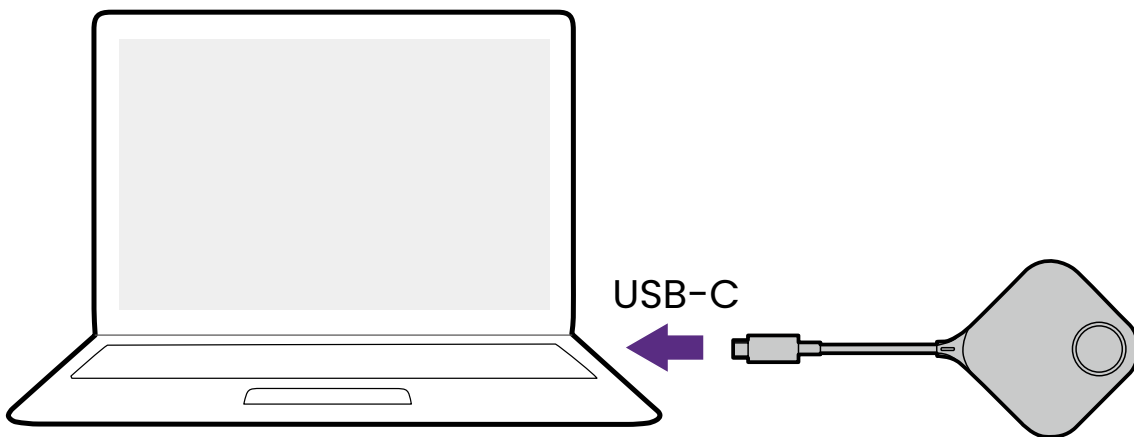

3. The LED indicator of the Button will flash green while the Button is starting up.

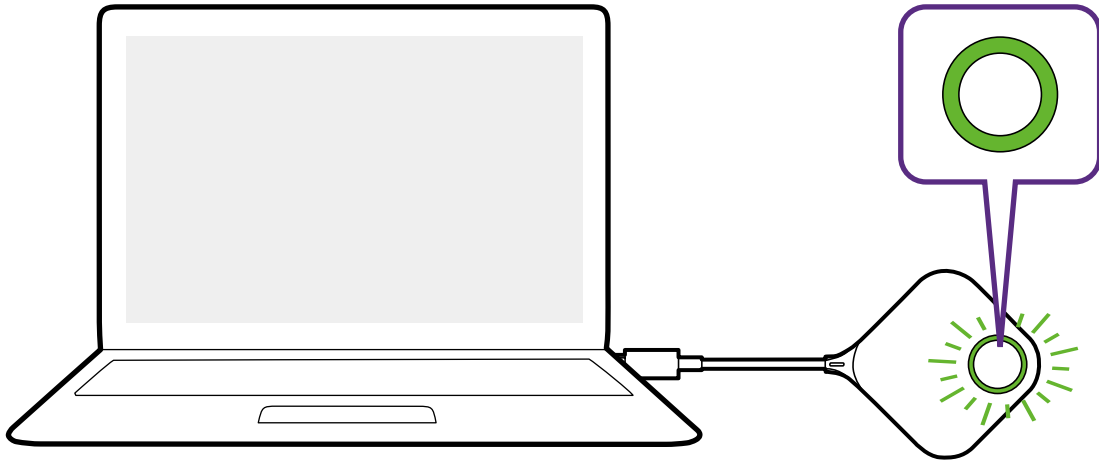

4. When the Button is ready to present, the LED indicator will turn solid green. Press the Present key when the LED indicator turns green.

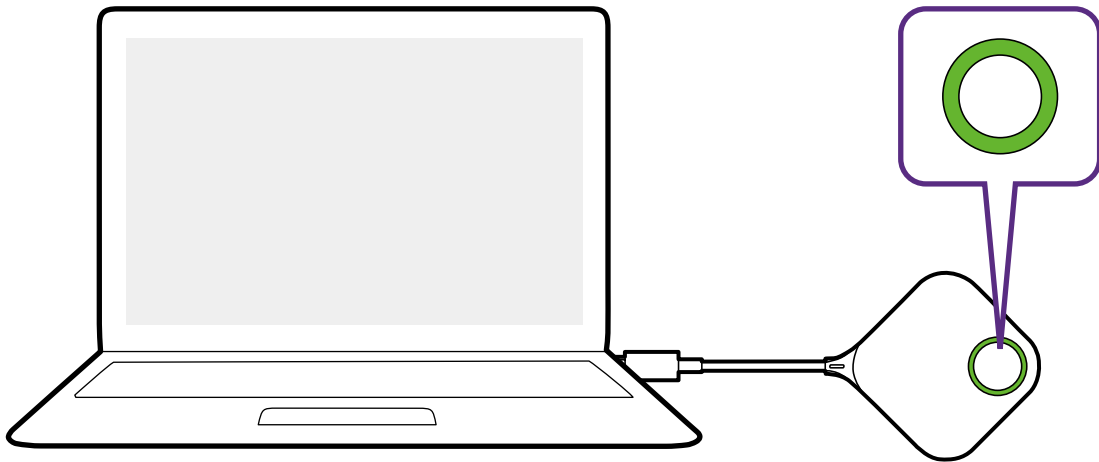

- Handle the Button cable with care. Rough handling might cause defects.
- Pull/Push the connectors instead of the cable when inserting or removing Buttons.

Pairing a Button and Host

A product set includes a Host and two Buttons, which are paired before shipment. In such a case, you don't need to pair them again. However, if you buy two or more product sets, and you want to pair a Button with a different Host, you need to follow the instruction below. If you buy an additional Button kit, and you want to pair the new Buttons with your Host, you need to follow the instruction below as well.

When the Host is placed on a table

1. Make sure your Host is ready with a power supply. Connect the Button to the corresponding input of a laptop.

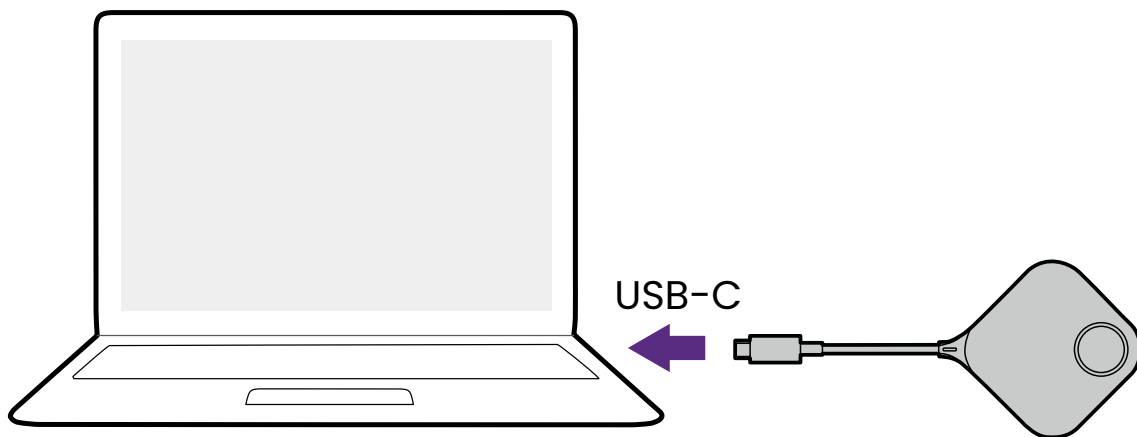

2. When the new Button is connected to the laptop, the LED indicator of the Button will flash red.

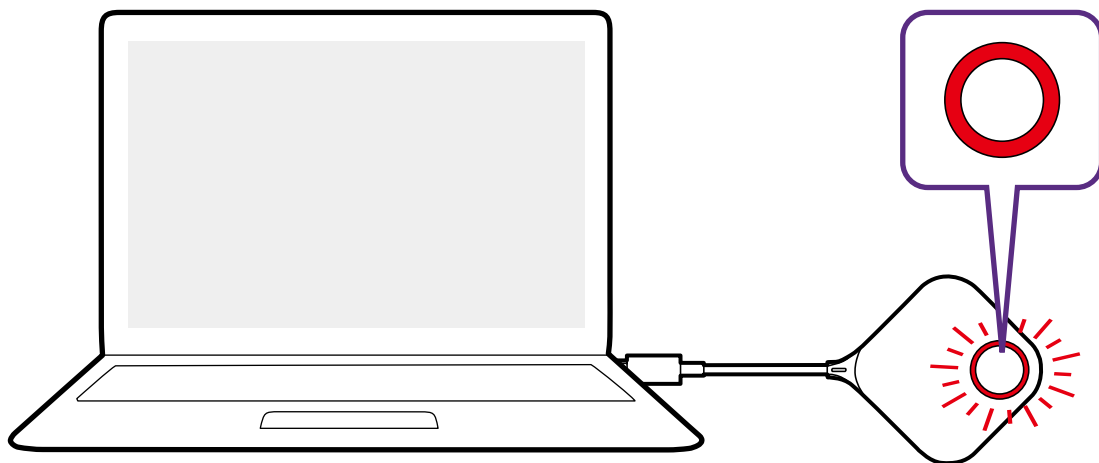

If a Button nearby has been paired with a Host before, it will turn static green.

3. Press the **PAIRING** key of the Host for five seconds, the LED indicator of the Host will blink blue for two minutes, waiting to pair with a Button.

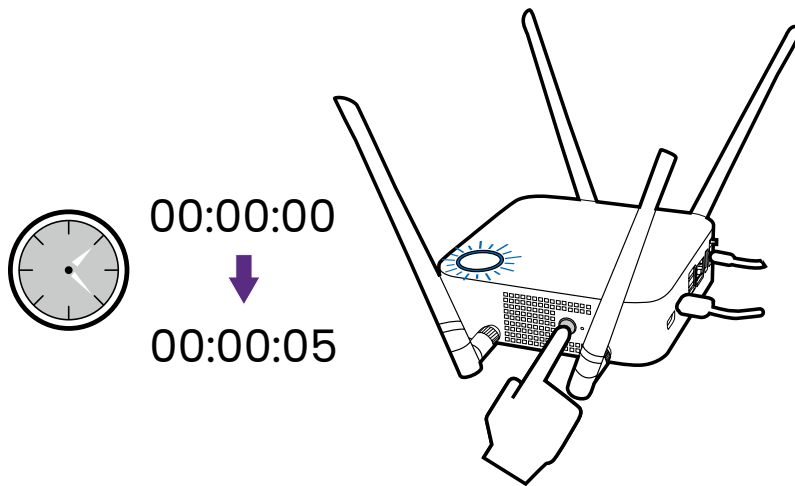

If the Host is attached to the ceiling so that it is not easy to press the **PAIRING** key, please use the pairing process in the web management interface. Refer to [Pairing on page 63](#) for information.

4. Press the split screen key on the side of the Button for five seconds. The LED indicator of the Button will blink blue for about 10 seconds. The pairing process is ongoing. The **"Pairing in progress"** message will be shown on the screen.

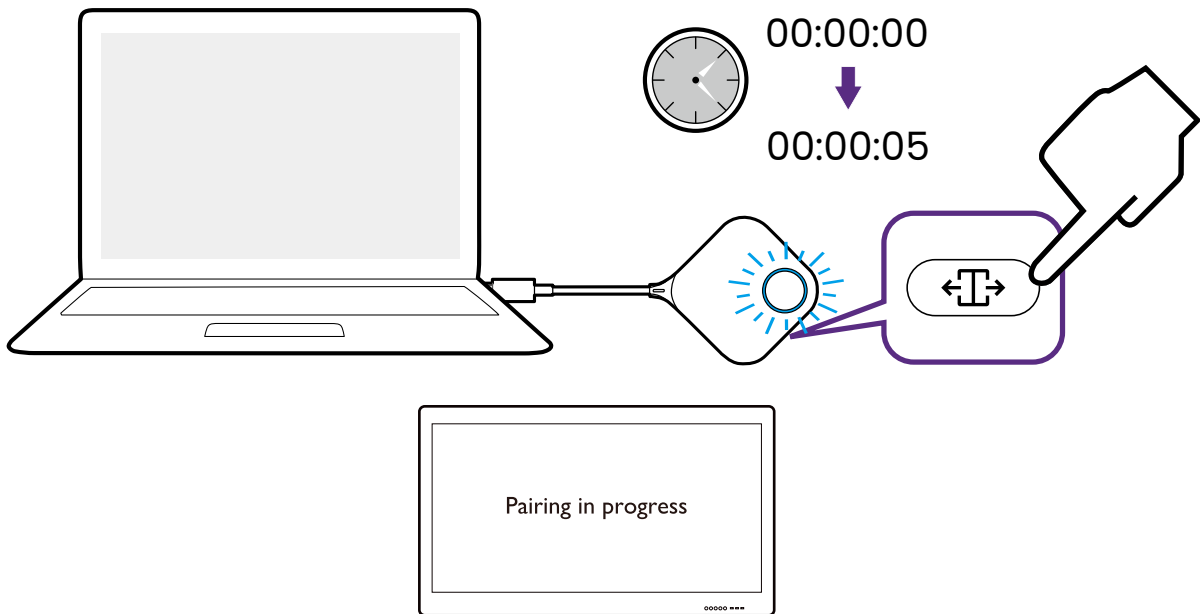

5. The LED indicator of the Button turns static green and a **“Pairing complete”** message will be shown when the Host and Button are successfully paired.

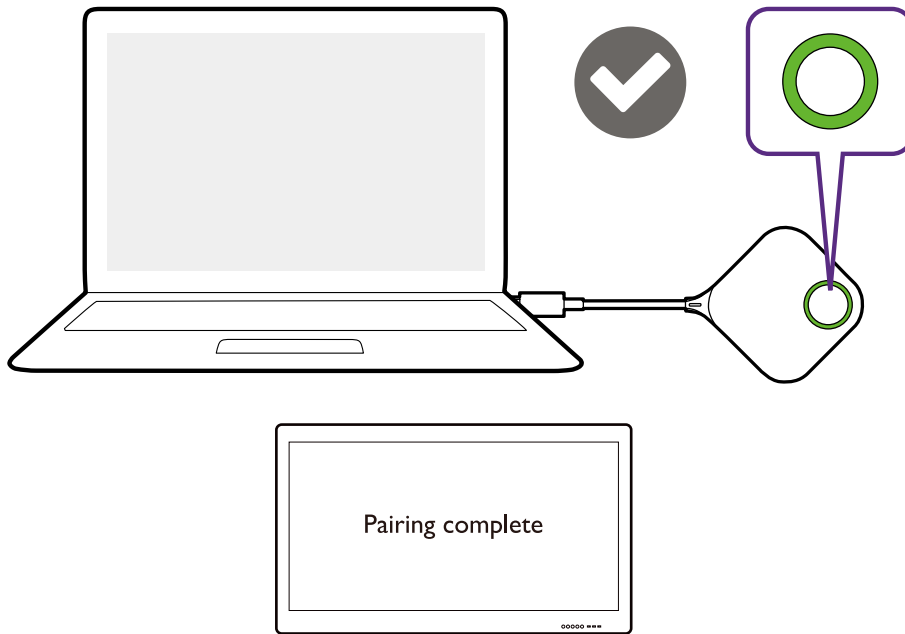

The maximum number of Buttons you can pair with one Host is 32.

Storing Buttons and USB cable in the cradle

You are provided with two different ways to store the Buttons in the cradle. Place the Buttons in the cradle vertically (1) or horizontally (2). See the illustrations below.

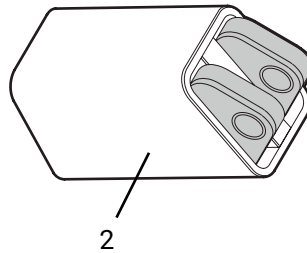
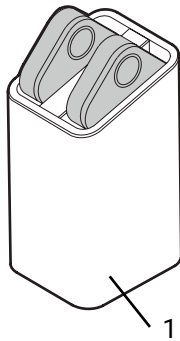

Resetting a Host

Resetting a Host allows you to return the Host to its original factory settings. You may want to reset the Host because of either one of the following reasons:

- You want to clear the web management interface of all changes made to its configurations, such as pairing information, passwords, SSID, etc. and return it back to its default settings. Refer to [Web management on page 48](#) for more information.
- You are unable to access the web management interface (for instance due to an altered or lost password).

Reset the Host using the following steps:

1. Connect the power port on the Host to a power source and wait for at least 90 seconds.



After the Host has been connected to a power source for at least 90 seconds, the Host LED may indicate any one of the statuses described in [LED indicators of the Button and the Host](#). As long as the Host has been connected to a power source for at least 90 seconds, you may proceed to the next step of the resetting process regardless of the status of the Host LED.

2. Poke the **RESET** hole at the rear of the Host with a pin for at least 5 seconds and then stop.

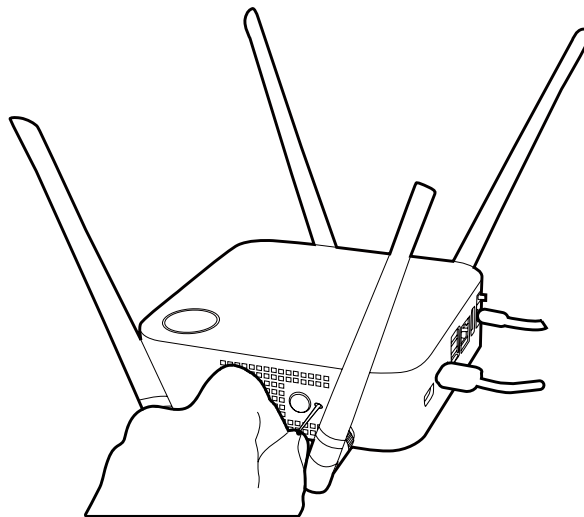

3. The Host LED will begin quick flashing red (flash red twice every second) for 10 seconds, then light up static white for 3 seconds, indicating that the Host is resetting.

4. Once the Host LED lights up static green the resetting process is complete.



Do not disconnect the Host from its power source at any time during the resetting process.

Resetting a Button

Resetting a Button allows you to return the Button to its original factory settings. You may want to reset a Button because of either one of the following conditions:

- You purchased an additional Button (via a Button Kit) which has not been paired to a Host.
- A Button that was included in the original package has been paired to a different Host (one which was not originally included with the Button in the package), and you want to quickly pair it back to its original Host.
- A Button that was included in the original package has been paired to a different Host (one which was not originally included with the Button in the package), and you want to re-pair the Button to its original Host while the Host is not powered on.

Reset a Button using the following steps:

1. Connect the USB connector on the Button to a powered-on laptop and wait for at least 30 seconds.

 After the Button has been connected to a powered on laptop for at least 30 seconds, the Button LED may indicate any one of the statuses described in [LED indicators of the Button and the Host](#). As long as the Button has been connected to a powered on laptop for at least 30 seconds, you may proceed to the next step of the resetting process regardless of the status of the Button LED.

2. Poke the **RESET** hole at the bottom of the Button with a pin for at least 5 seconds.

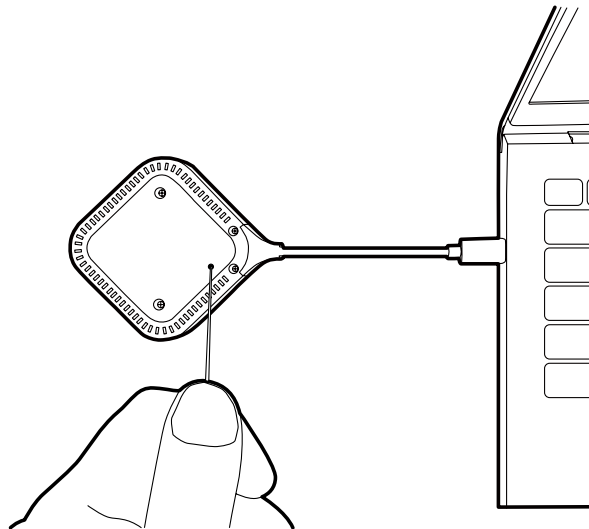

3. The Button LED will begin quick flashing red (flash red twice every second) for 10 seconds, then light up static white for 2 seconds, indicating that the Button is resetting.
4. Once the Button LED lights up static green the resetting process is complete.

 Do not disconnect the Button from its power source at any time during the resetting process.

Enabling network standby mode

You can set the Host to enter network standby mode after a period of inactivity. To set the time of inactivity, go to **Web Management > Advance Setting > Network Standby**. See [Advance Setting on page 66](#) for more information.

To enable network standby mode, do one of the following:

- wait for the Host to enter network standby mode automatically if no wireless devices (e.g., a Button, a mobile device, or a laptop) being connected to the Host's SSID and no data (from any USB devices such as a mouse, a keyboard, or from touch back function) being transmitted to the Host within the set time.
- if there is no wireless devices being connected to the Host's SSID within the set time, press the standby button on the Host to enable network standby mode immediately.

The LED indicator on the Host lights up static white when it is in network standby mode.

The network standby mode is disabled when

- a wireless device is connected to the Host's SSID; or
- data (from any USB devices such as a mouse, a keyboard, or from touch back function) is transmitted to the Host; or
- you press the standby button on the Host.

Starting and stopping presentations

This section will guide you on how to start and stop a presentation using the product.

Getting ready

Make sure that all the connected devices have been powered on and ready for the presentation.

As the product could work with different projectors, IFPs, TVs, or monitors with standard HDMI ports, the steps required to start a presentation may vary according to the actual environment and your display specifications. Follow the procedures below and refer to the specified sections for details.

1. To start a presentation, see [Starting presentation on page 34](#) for details.
2. To stop a presentation, see [Idle presentation on page 35](#) for details.
3. To start a split-screen presentation, see [Split screen presentations on page 36](#) for details.
4. To start a presentation with a mobile device, see [Touch back on page 38](#) for details.
5. To control presentations via a touchscreen displays or mouse/keyboard see [Touch back on page 38](#) for details.

Starting presentation

1. Make sure power is supplied to the Host. See [Connecting the HDMI cable and power on page 21](#) for more information.
2. Choose the HDMI source corresponding to the Host on the display. You will see the Guide screen.

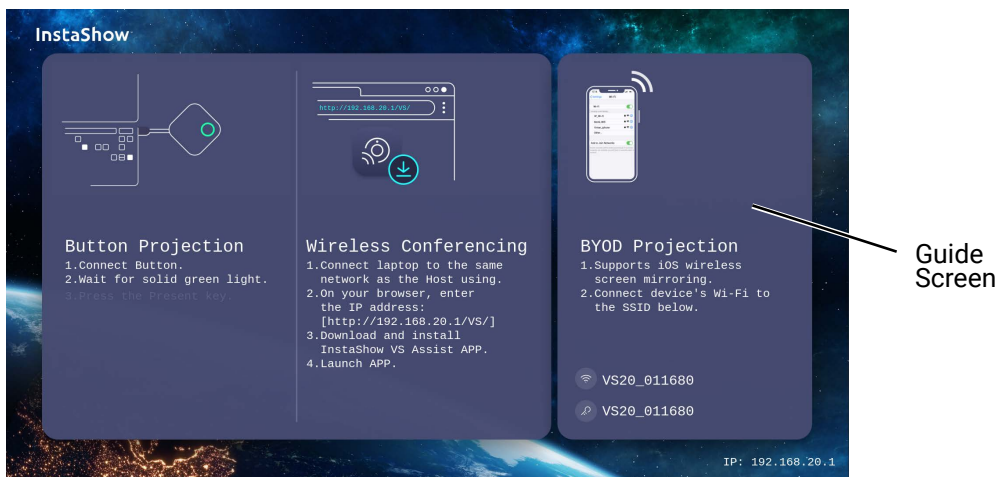

3. Please follow the instruction on the Guide screen to supply power to the Button. You can also see [Setting up and powering a Button on page 25](#) for more information. The LED indicator on the Button is static green when the Button is connected and working properly.
4. To start a presentation, press the Present key.

5. The device starts presenting, and the LED indicator of the Button turns static blue.

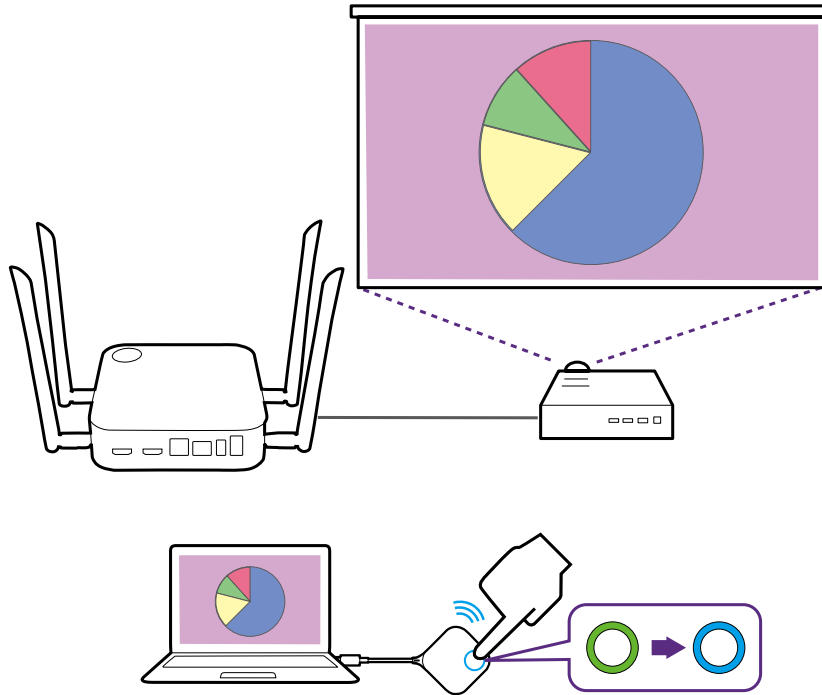

- Make sure the transmission distance between the Button and Host is within 15 meters and with no obstacles.
- The product supports MacBooks and Windows laptops to mirror an extended desktop.

Idle presentation

1. To stop a presentation, press the Present key.
2. The device stops presenting, and the LED indicator of the Button turns green.
3. Users can press the Present key to return to the presentation.

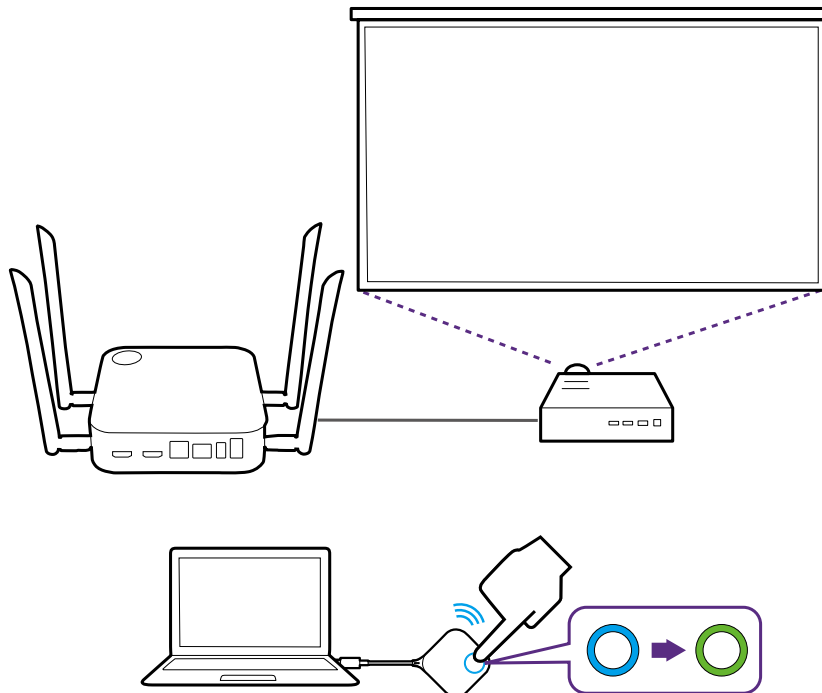

Split screen presentations

The product allows up to 4 users to present simultaneously in a split screen orientation.

Starting a split screen presentation

1. Connect a Button to each computer that will be presenting in the split screen presentation. See [Setting up and powering a Button on page 25](#) for more information.

 Make sure that all Buttons have already been paired to the Host projecting the presentation. See [Pairing a Button and Host on page 28](#) for more information.

2. Start a normal presentation using one of the Host buttons. See [Starting presentation on page 34](#) for more information.

3. Press the split screen button on the Host that started the presentation to enable split screen presentations.

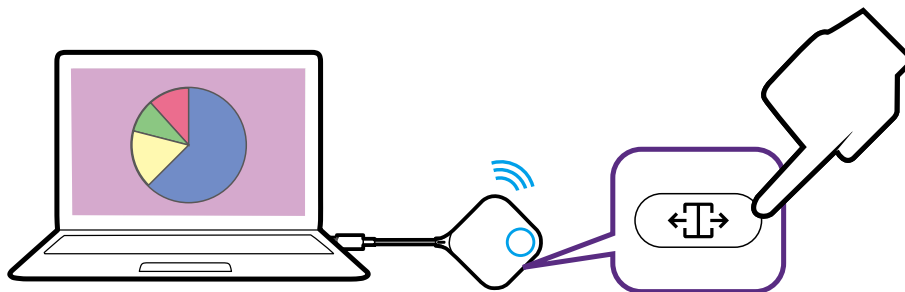

4. Once a notification appears on-screen indicating that the split screen function has been enabled, press the Present key on the Button of the second computer that wants to join the split screen presentation.

5. Repeat step 4 for all other users that want to join the split screen presentation.

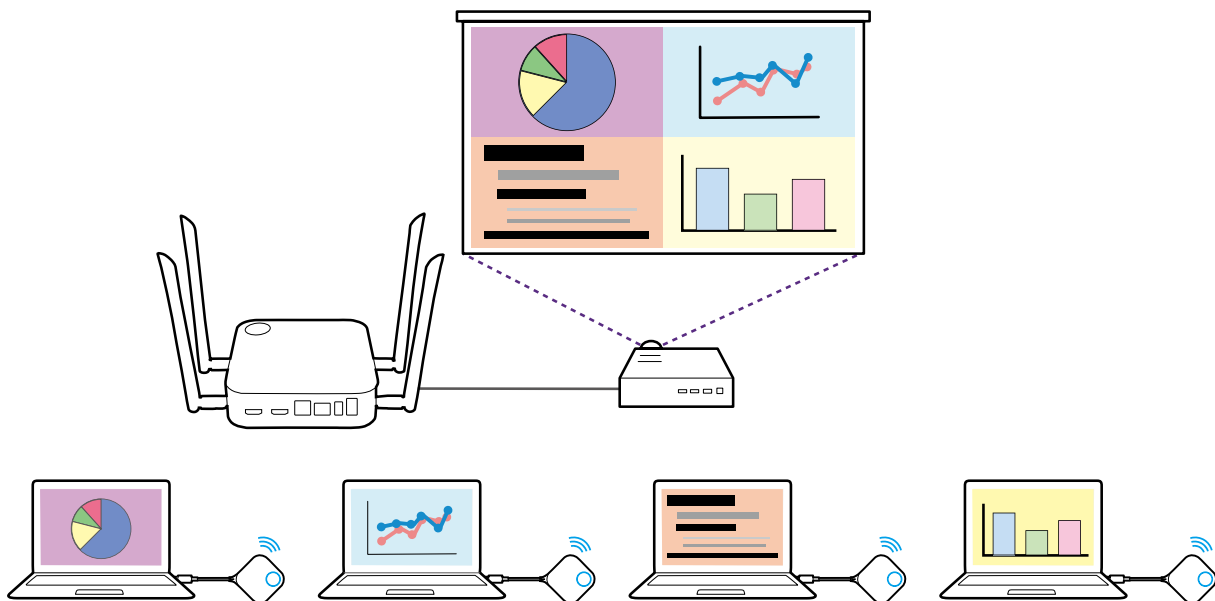

-
-  • Only up to 4 users are simultaneously supported in a split screen presentation.
• The layout of the split screen presentation will be dictated by the amount of users in the presentation.
• If split screen is not enabled by the initial Button, all subsequent connections by other Buttons will be full screen presentations.
-

Switching from a split screen to a full screen presentation

Once in a split screen presentation you can switch to a full screen presentation of any of the participant's screen by pressing the split screen button on the Button of the computer that wants to present in a full screen.

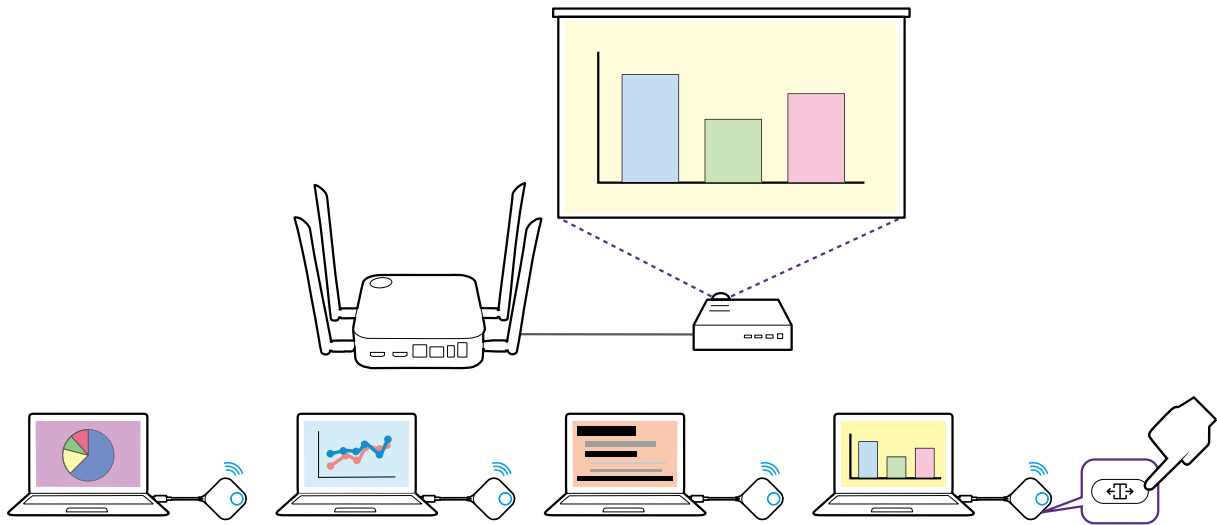

To return to a split screen presentation repeat the steps in [Starting a split screen presentation on page 36](#).

Presenting with mobile devices

InstaShow supports both iOS and Windows wireless communication's screenmirroring capabilities for presenting via mobile devices. To present using a mobile device, connect the mobile device's Wi-Fi to the SSID of the Host and then follow the steps for your mobile device's wireless communication to screencast.



If you are unsure of your Host's SSID you can check the SSID shown on the top-left corner of the Guide screen.

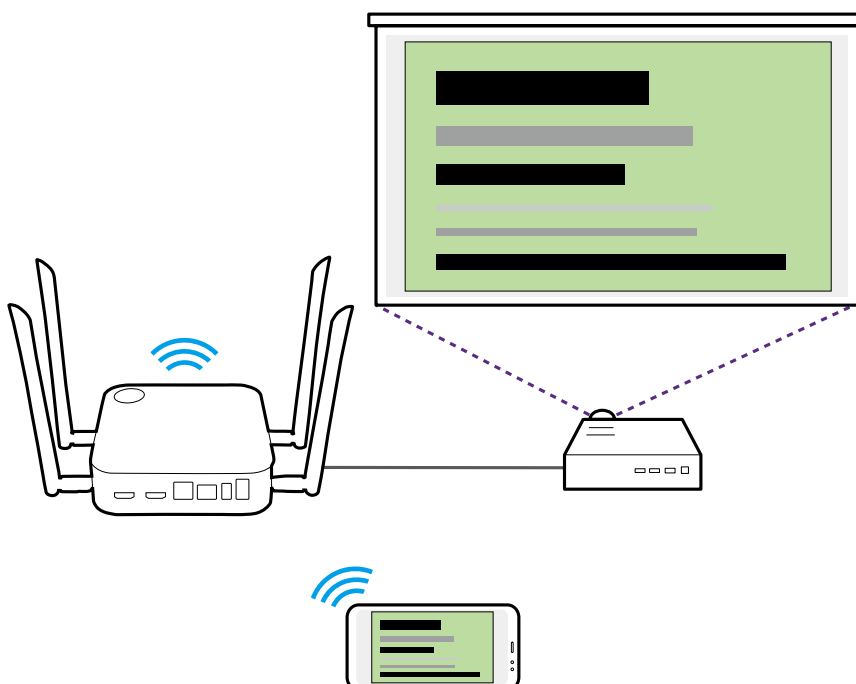

Touch back

When a Host is connected to a touchscreen display and a PC is presenting via a Button, you can use a USB Type-A cable to connect the **TOUCH SCREEN** USB port located at the rear of the Host to the touch input USB port of the display to control the interface of the PC remotely via touch gestures on the display.

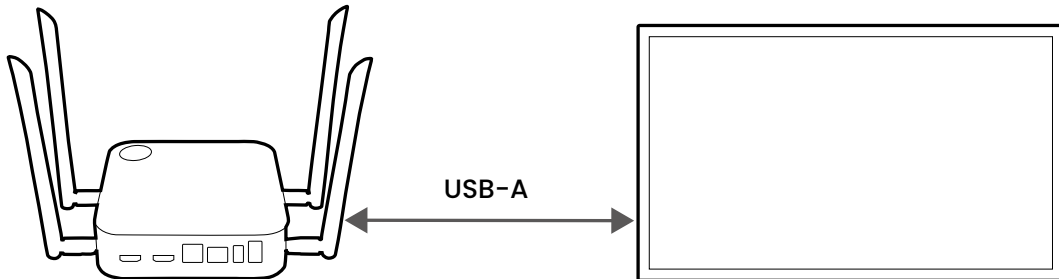

The product only supports touch back for Windows-based PCs. It does not support touch back for MacBooks or smartphones connected via their respective screencasting technology.

Using InstaShow in hybrid meetings

InstaShow is a wireless presentation system that can be fully integrated into any hybrid meeting that uses videoconferencing applications to link remote participants, so that those participants are also able to view and interact with any content being broadcast in the conference room by InstaShow.

Setting up a videoconference

To set up a videoconference with InstaShow:

1. Connect the InstaShow Host to a network with Internet access using one of the following methods:
 - Connect the Host's **WAN** port to the network router using an RJ-45 cable. Refer to [LAN connection on page 23](#) for more information.
 - Connect the Host to the router's Wi-Fi network. Refer to [Wi-Fi connection on page 23](#) for more information.

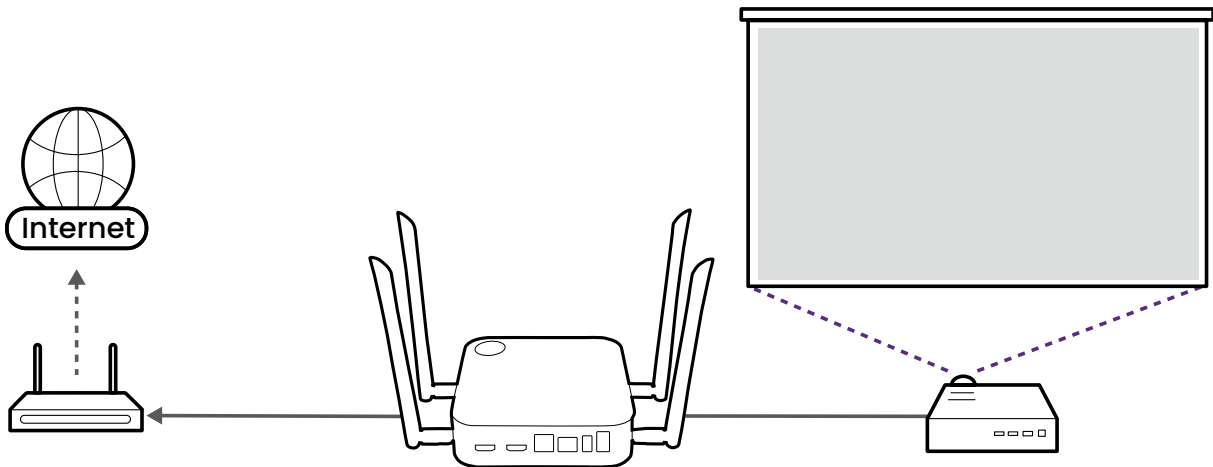

2. Connect the laptop that will be running the videoconferencing application to the same network as the Host using one of the following methods:

- Connect the laptop's Wi-Fi to the SSID of the Host listed on the top-left corner of the InstaShow Guide screen.
- Connect the laptop's Wi-Fi to the SSID of the network router.

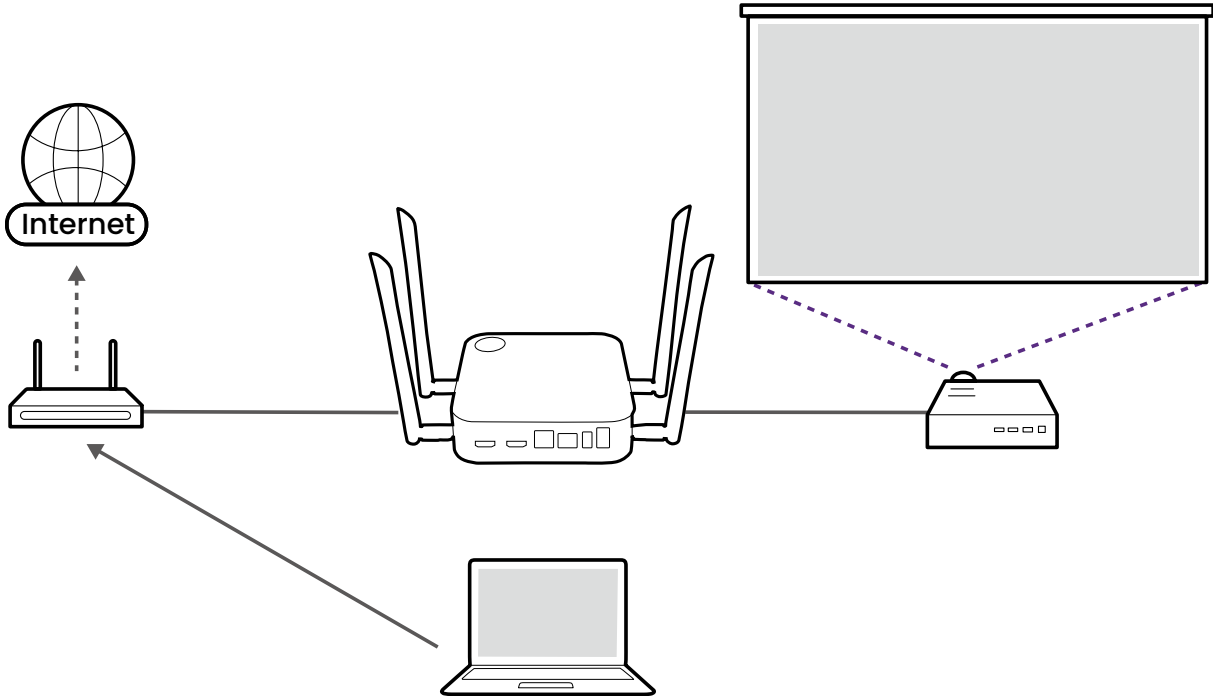

- It is recommended to connect to the Host's SSID for faster transmission speed.
- If you are unsure of your Host's SSID you can check the SSID shown on the top-left corner of the Guide screen.

3. Download and install the **InstaShow VS Assist** app on the laptop from the URL shown on the InstaShow Guide screen.

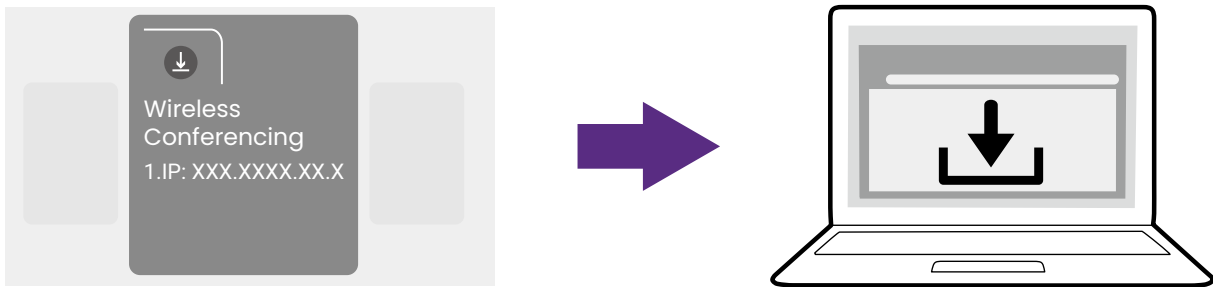

4. Launch the **InstaShow VS Assist** app.



5. Select **Room List** on the app's home screen.

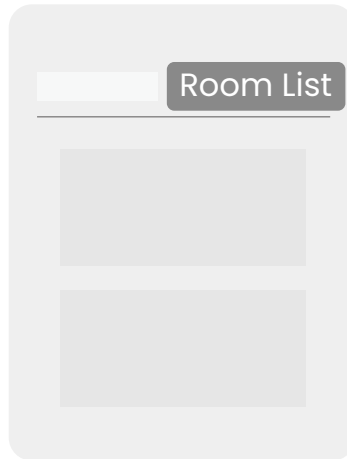

6. Select the search (magnifying glass) button in the app and it will search the network for all available Hosts.

7. Double-click the name of your respective Host under the **Room Name** column.



 If you are unsure of your Host's name you can also cross check the IP address shown in the **IP Address** column of the app with the IP address shown on the top-left corner of the Guide screen.

8. Select **InstaShow Display Sharing** on the app's home screen. A new window will pop up on the laptop showing the video that is being broadcast by the Host.

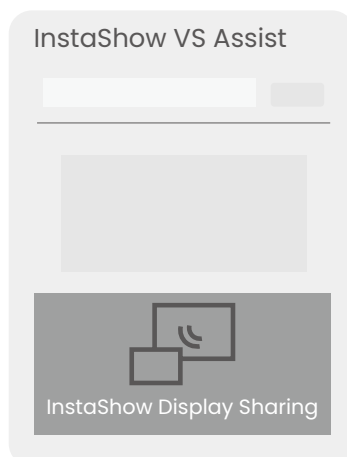

9. Start a videoconference and then share the **InstaShow Display Sharing** pop-up window in the videoconferencing application.

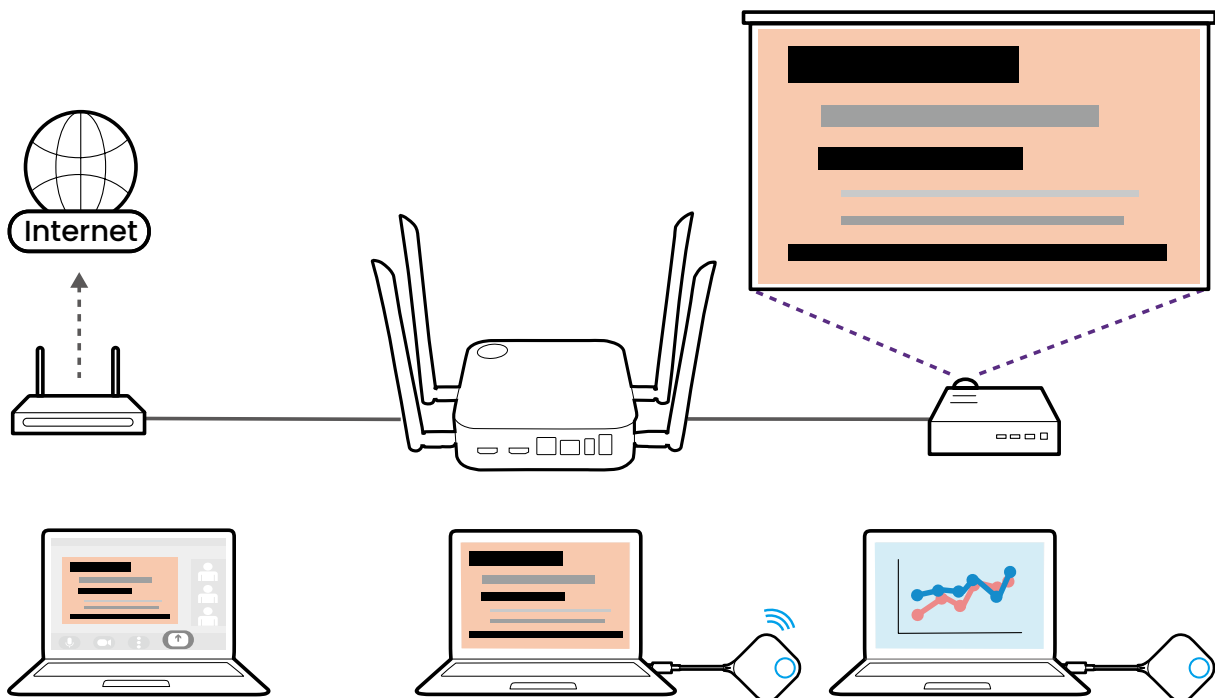
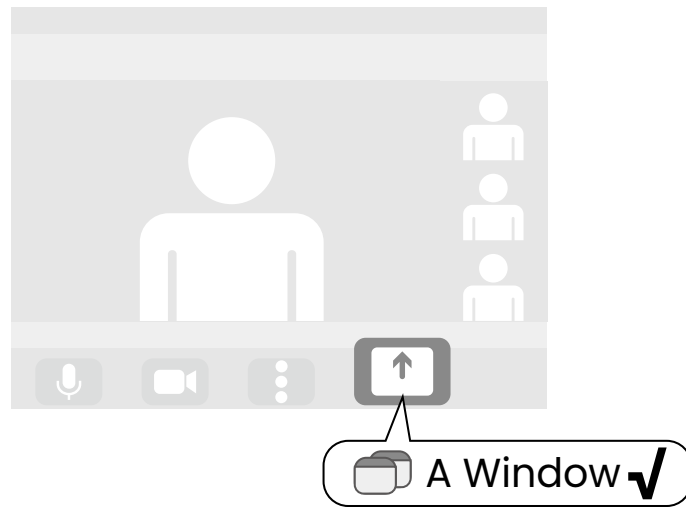

Using an external webcam

Within a hybrid meeting, you can also switch from the webcam on the laptop to an external webcam so that remote users are able to get a clear view of the full conference room during the meeting.

To switch to an external webcam in your hybrid meeting:

1. Connect a webcam to one of the **USB 3.0** ports on the Host.

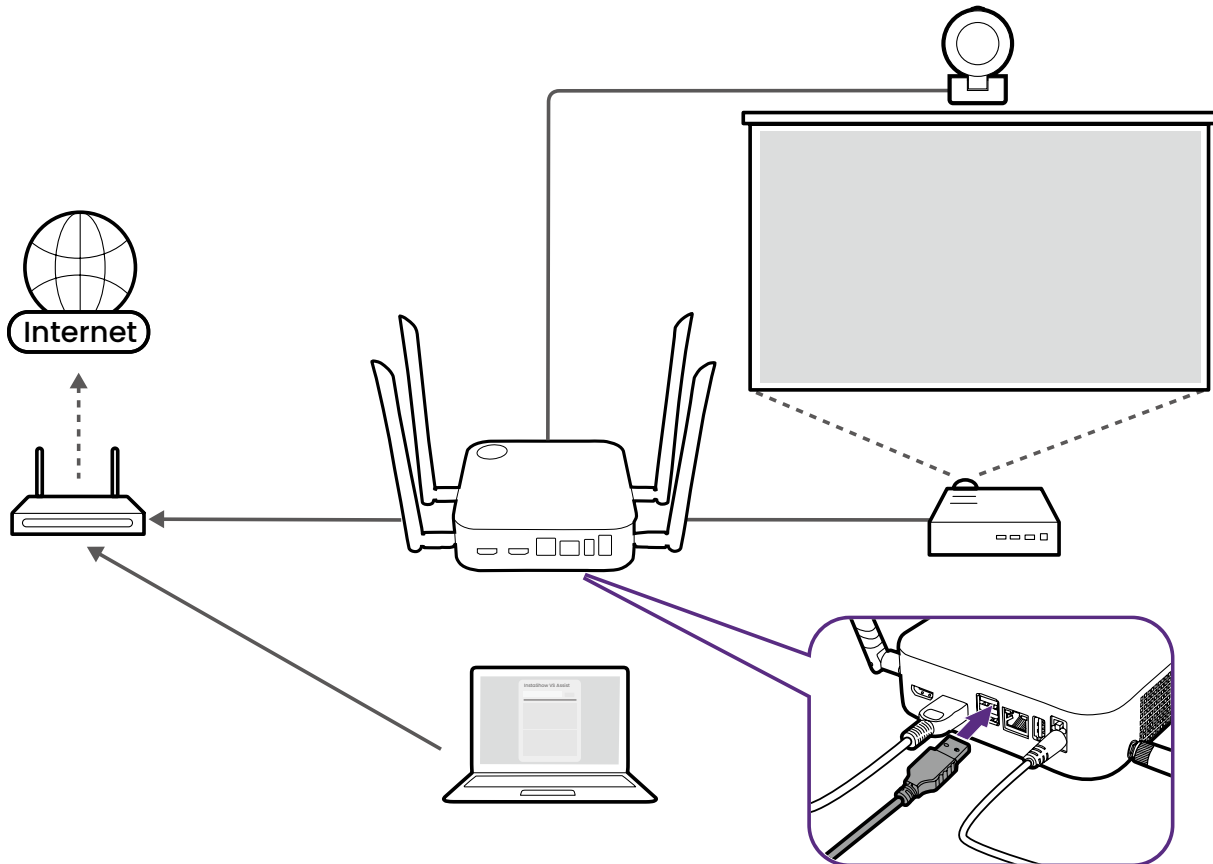

2. Follow the steps in [Setting up a videoconference on page 39](#) to begin a videoconference.
3. (Optional) Select **InstaShow Camera Preview** on the **InstaShow VS Assist** home screen to preview the video captured by the webcam so that you can check to see whether you have connected to the correct webcam.

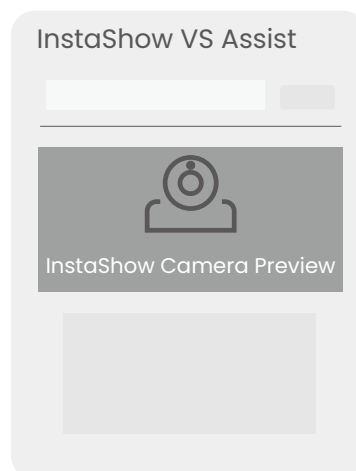



If the preview video shown is not from your webcam, repeat the process and ensure that the correct **Host/Room Name** is selected in the app.

5. Open the webcam input source menu in the videoconferencing application and select **InstaShow Camera**.

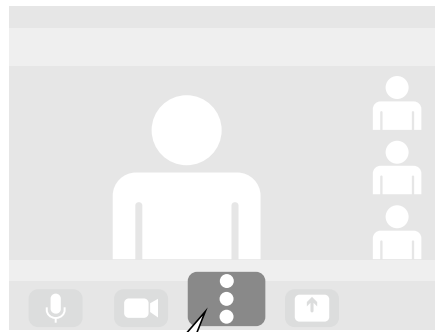

InstaShow Camera ✓

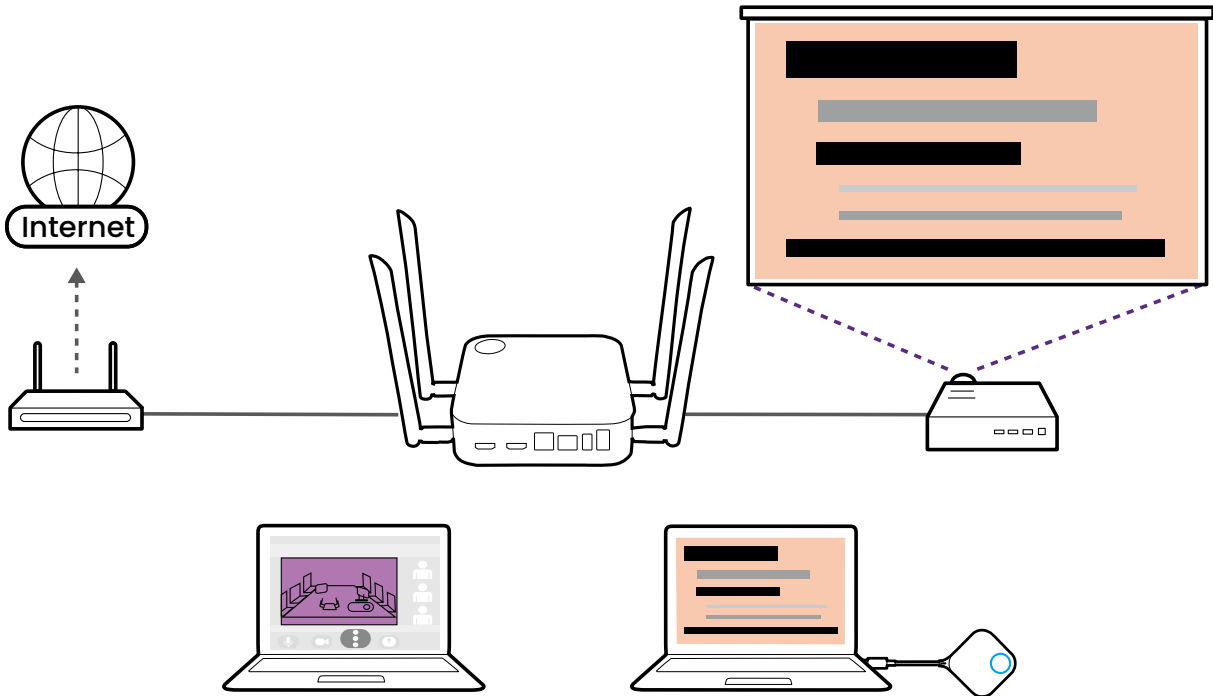

Using a single InstaShow Button as a microphone

For hybrid meetings where you do not have a webcam with a built-in microphone or the microphone on the laptop running the videoconferencing application does not adequately capture all the sound in the room, you can use the InstaShow Button as a microphone.

To use a Button as a microphone for your hybrid meeting:

1. Follow the steps in [Setting up a videoconference on page 39](#) to begin a videoconference.
2. Connect a Button to the corresponding port(s) on the laptop running the videoconferencing application.

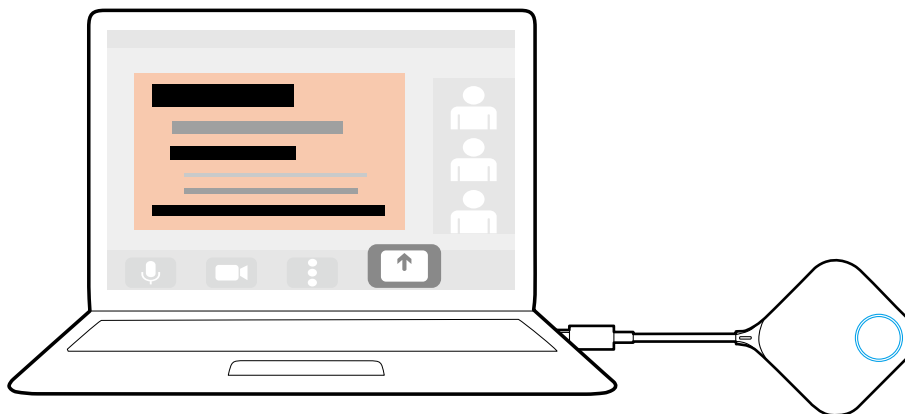

3. Open the microphone input source menu in the videoconferencing application and select **InstaShow Button Microphone**.

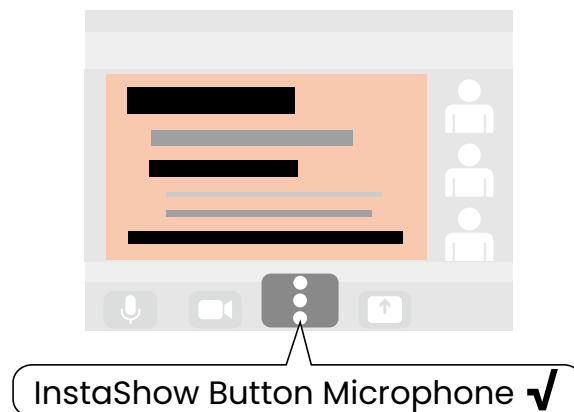

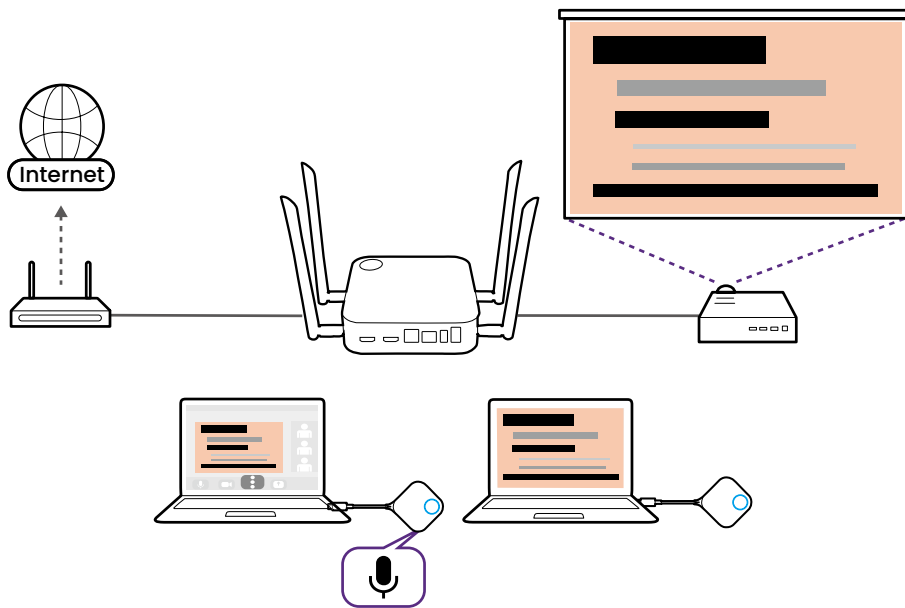

Using multiple InstaShow Buttons as microphones

For hybrid meetings in larger conference rooms, you can use multiple InstaShow Buttons connected to laptops throughout the room as an array of microphones that is able to capture sound from every corner of the room and transmit that sound to any person participating in the videoconference.

- When using multiple InstaShow Buttons as microphones, any peripheral device with microphone capabilities connected to USB ports at the rear of the Host, will also be used in tandem with the InstaShow Buttons as part of the microphone array.
- Before creating a microphone array using multiple Buttons, the laptop that will run the videoconferencing app within the conference room must first download and install the **InstaShow VS Assist**.

To use multiple Buttons as a microphone array for your hybrid meeting:

1. Follow the steps in [Setting up a videoconference on page 39](#) to begin a videoconference.
2. Connect a Button to each of the laptops throughout the room that you want to use as part of the array.

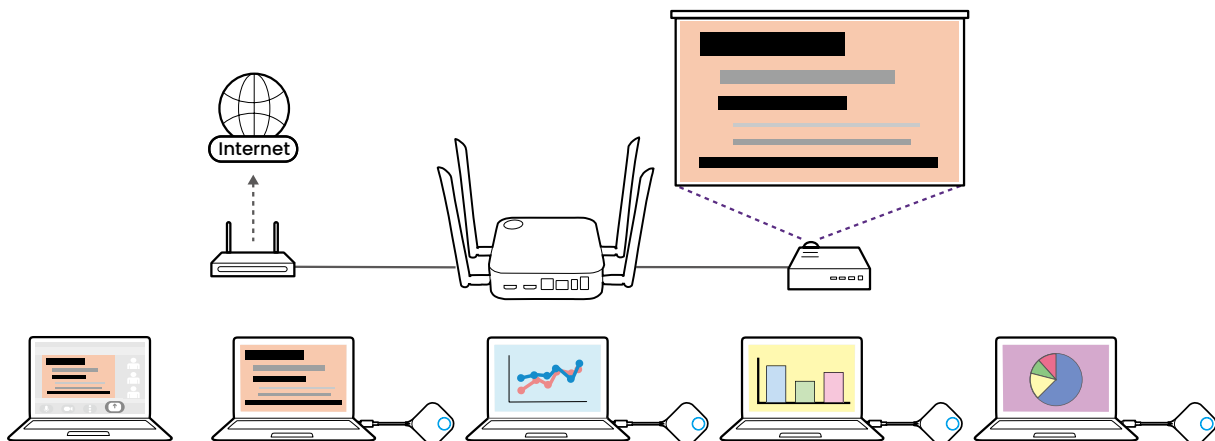

3. Open the microphone input source menu in the videoconferencing application and select **InstaShow Audio**.

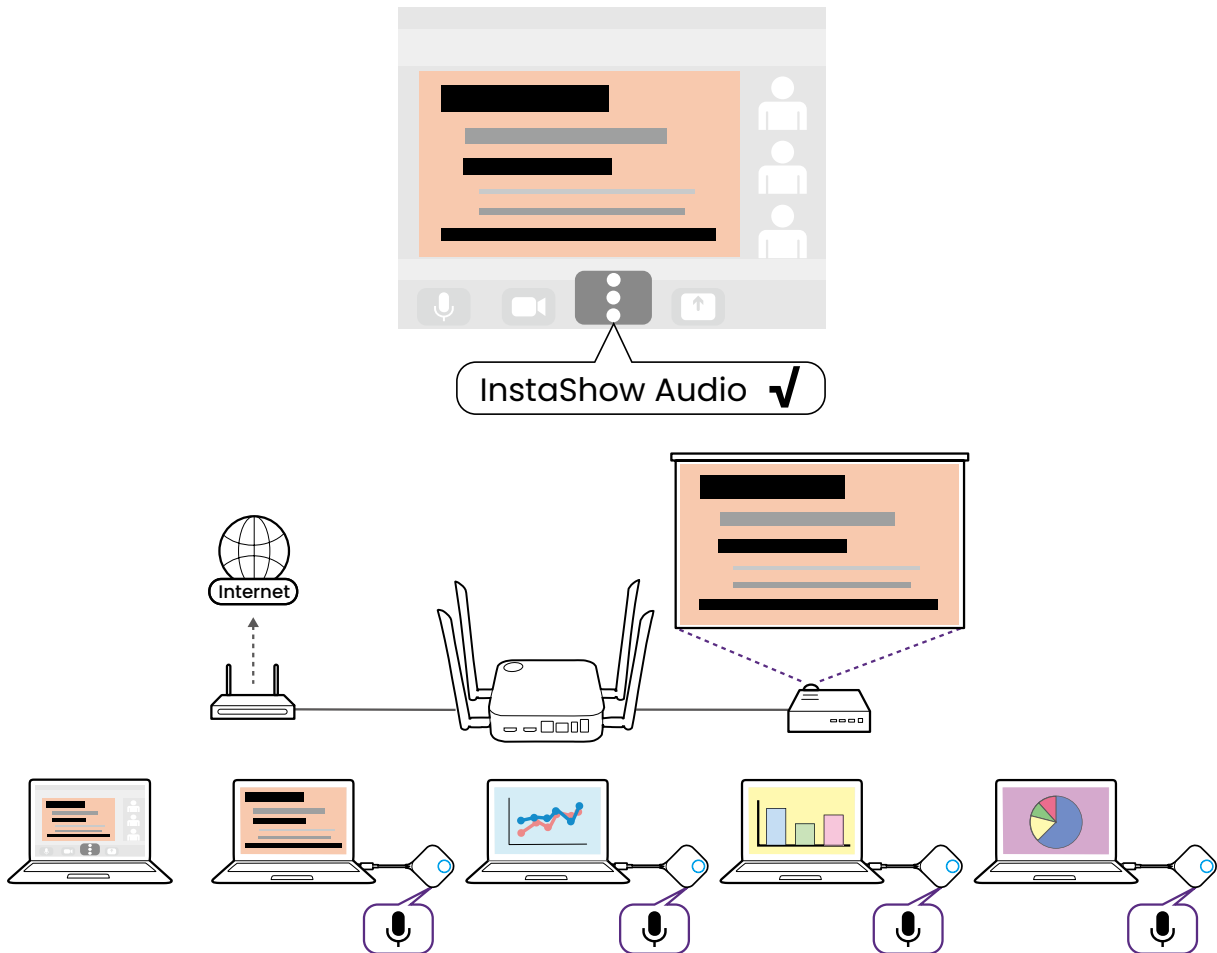

For hybrid meetings that feature an external webcam with a built-in microphone connected to the Host, the resulting microphone array will also include the microphone on the webcam.



- To disable a single microphone/Button when using a microphone array, use the Mute key located on the corresponding Button.
- To disable and/or configure the microphone array feature, use to the **Peripheral Settings** menu in the web management interface. See [Peripheral Settings on page 60](#) for more information

Connecting another WPS to the Host

For conference rooms that feature another Wireless Presentation System that does not support videoconferencing, you can connect that WPS to the Host to integrate it into the hybrid meeting.

To connect another WPS to your host:

1. Follow the steps in [Setting up a videoconference on page 39](#) to begin a videoconference.
2. Use an HDMI cable to connect the HDMI output port on the other WPS to the **HDMI IN** port on the Host.

Once connected you can use the transmitters from the other WPS to present on InstaShow which will then also be shared with remote participants in the videoconference.

Web management

The product is equipped with a web management interface that enables you to configure its features through a browser such as Google Chrome (version 49.0.26), Internet Explorer (version 8.0), or Firefox (version 46.0.1).



The features may vary according to different firmware versions.

Accessing the web management interface

Logging into the web management interface via direct connection



When your Host is connected to a Wi-Fi network via the steps in [Wi-Fi connection on page 23](#), you will not be able to access the web management interface via a direct connection. Instead, follow the steps in [Logging into the web management interface via a wireless network on page 51](#) to access the web management interface.

1. Connect your Host directly to a laptop using a network cable (RJ-45) and to a power source using the power adapter.

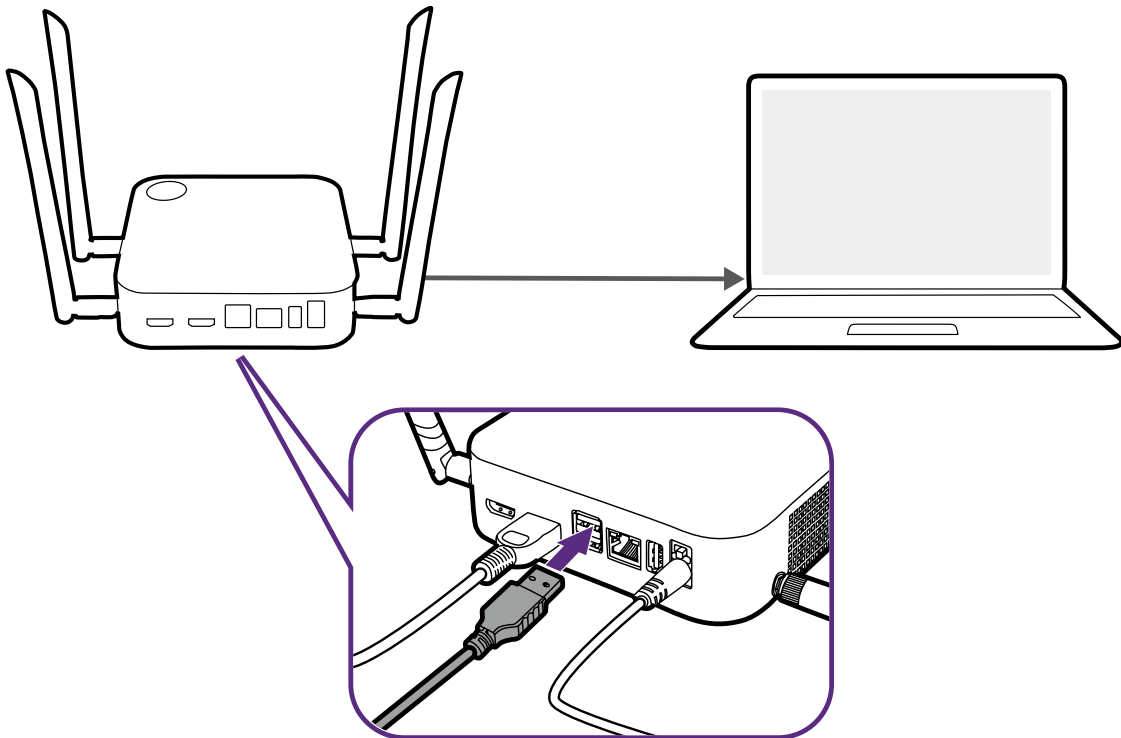

2. Wait until the LED indicator on your Host lights up static green.

3. The default IP address of your Host is 192.168.20.1 Change your laptop's IP address to 192.168.20.x (e.g. 192.168.20.100).

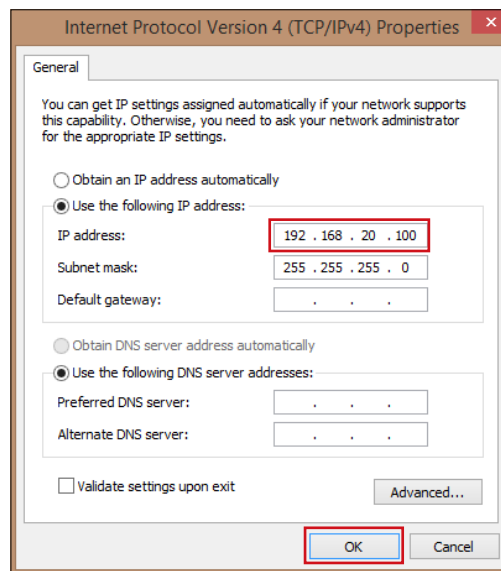
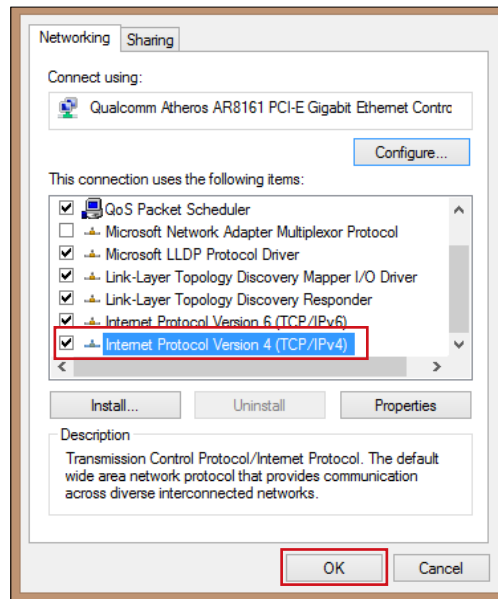

4. On your browser, enter the IP address: 192.168.20.1 At the first access to the web management interface or after a firmware upgrade, you may be prompted to change the password to proceed. Enter the default password (0000) as the old password, and set a new one.

Please input the old password

Please input the new password

Please input the password again

Reset

If you are not requested to change the password on the login page, enter the default user name (admin) and your password (as changed earlier).

Please input account

Please input password

Login

5. You will successfully log into the web management interface.

Logging into the web management interface via LAN

If your Host is connected to your LAN, you can enter the IP Address shown on the screen via a web browser.

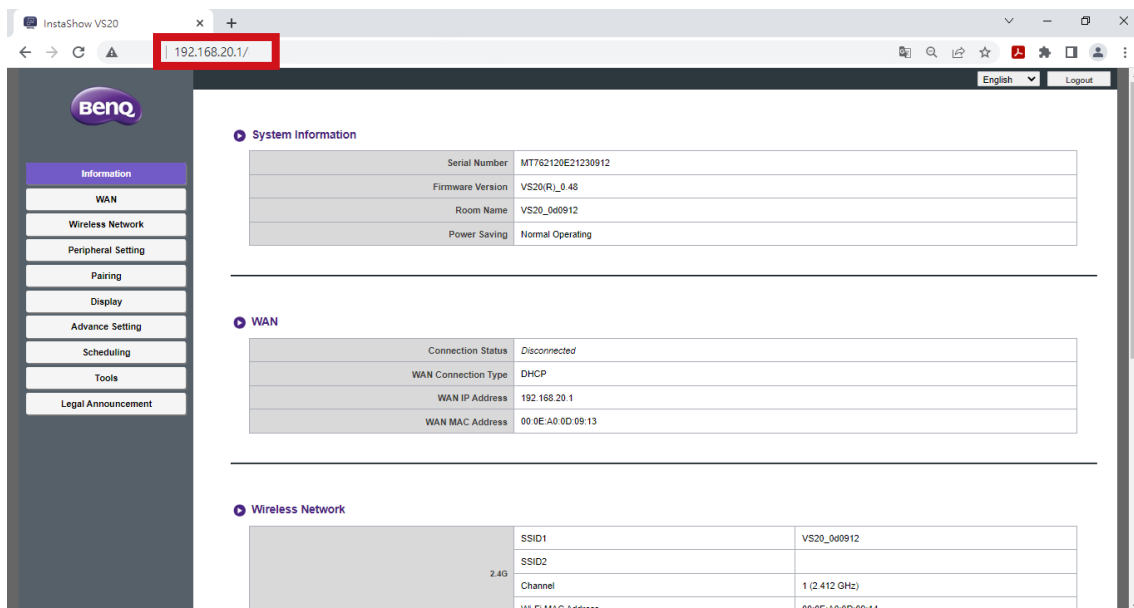
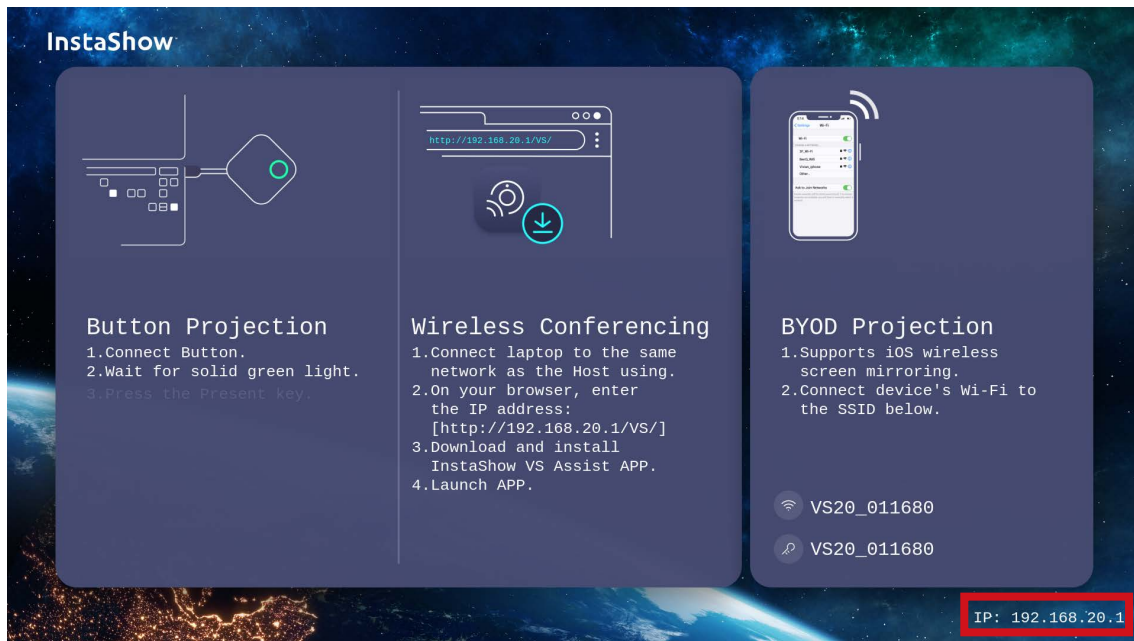

Logging into the web management interface via a wireless network

The product supports 802.11 ac/n. It is compatible with most devices with Wi-Fi capability (e.g. laptop or mobile devices), you can locate the Host via the VS20_xxxxxx SSID (shown in the Guide/Idle screen) in your laptop or mobile device's wireless network menu and connect to it. The default password is the same as the name of the SSID (for example, if the SSID is "VS20_374DEF", the password will be "VS20_374DEF"). When the device is connected to the Host, enter the IP Address, "192.168.0.92" in a web browser, then enter the user name and password as shown in step 4 of [Logging into the web management interface via direct connection on page 48](#).

The following is an example of how you can log into the web management interface via a mobile device with a wireless connection.

1. Go to Wi-Fi menu of the mobile device, and you can find the SSID of your Host: VS20_0d0912.

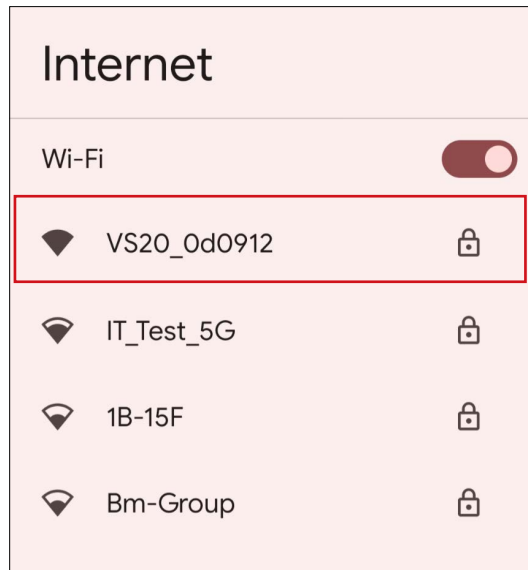

2. Enter the default password "VS20_0d0912" and press **Connect**.

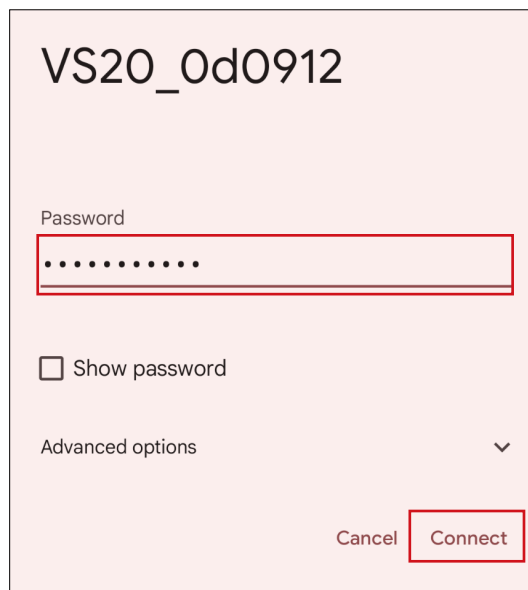

3. Access the web management interface following step 4-5 of [Logging into the web management interface via direct connection on page 48](#).

Getting started

You can now use the web management interface to configure various settings of your Host.

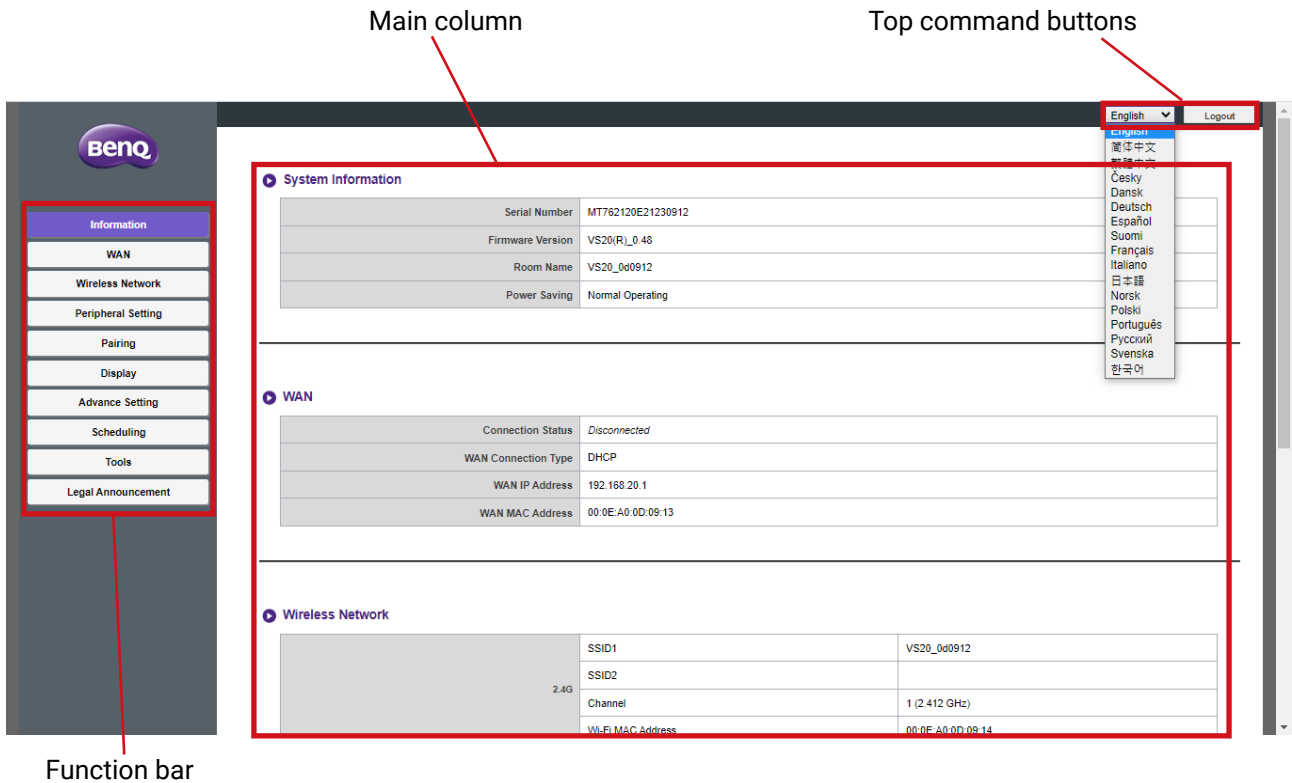

Top command buttons

Change language

1. The default language is English. To change the interface language, go to the language settings panel and you can see all available languages.
2. Click the language you want to switch to and your new language will be set.
3. Once a new language has been set both the web management interface and the product's OSD will feature the new language.



Supported languages vary by country/region where you purchase.

Logging out

Click **Logout** on the upper right corner.

Function bar

The function bar shows the settings menus available in the web management interface.

Main column

The main column shows the detailed content from the function bar.

Information

Click **Information** and you will see detailed information for **System Information**, **WAN**, **Wireless Network**, **My Screen**, and **Screen Message**.

The screenshot shows the BenQ Information menu on the left, with 'Information' highlighted. The main content area displays the following sections:

- System Information**

Serial Number	WDHBN002203G
Firmware Version	VS20(R)_0.91
Room Name	VS20_0de7f4
Power Saving	Normal Operating
- WAN**

Connection Status	Disconnected
WAN Connection Type	DHCP
WAN IP Address	192.168.20.1
WAN MAC Address	00:0E:A0:0D:E7:F5
- Wireless Network**

2.4G	SSID1	VS20_0de7f4
	SSID2	
	Channel	2 (2.417 GHz)
	Wi-Fi MAC Address	00:0E:A0:0D:E7:F6
5G	SSID1	VS20_0de7f4
	SSID2	
	Channel	48 (5.240 GHz)
	Wi-Fi MAC Address	00:0E:A0:0D:E7:F7
Wi-Fi Area	A SKU	
- Screen Message**

Input field:

Buttons:
- My Screen**

Guide Screen	Original
Idle Screen	Original

System Information

The **System Information** sub-menu lists the following basic system information for the Host:

- **Serial Number**
- **Firmware Version** - To update the firmware, see [Firmware Upgrade on page 70](#).
- **Room Name** - The room name is based on the SSID for the Host. To change the SSID, see [Setting on page 58](#) for more information.



If the SSID (**Room Name**) is changed, you need to pair the Button(s) to the Host again.

- **Power Saving** - Lists if the Host is currently in normal or standby mode.

WAN

The **WAN** sub-menu lists the following information for the Host's WAN connections:

- **Connection Status**
- **WAN Connection Type** - Lists the way in which the Host obtains its IP address, subnet mask and default gateway information. For more information on configuring the **WAN Connection Type**, see [General on page 57](#).
- **WAN IP Address**
- **WAN MAC Address**

Wireless Network

The **Wireless Network** sub-menu lists detailed information for the **2.4G** and **5G** Wi-Fi frequency of the host including the SSIDs, Channels, and MAC addresses for each frequency along with the Host's **Wi-Fi Area**. For more information on configuring these items, see [Setting on page 58](#).

Screen Message

The **Screen Message** sub-menu allows you to add a message at the top of the Guide/Idle screens.



To add a screen message enter the text you want shown on the screens in empty field and then press **Apply** to save your message. Your message will be shown at the top of the Guide/Idle Screen.



The character limit for the **Screen Message** is 64 alphanumeric or Chinese characters.

My Screen

The **My Screen** sub-menu allows you to customize the **Idle Screen** and **Guide Screen** that is shown when the Host is connected to a projector or display.

Background Image Guide Screen



Tutorial Boxes

Background Image Idle Screen

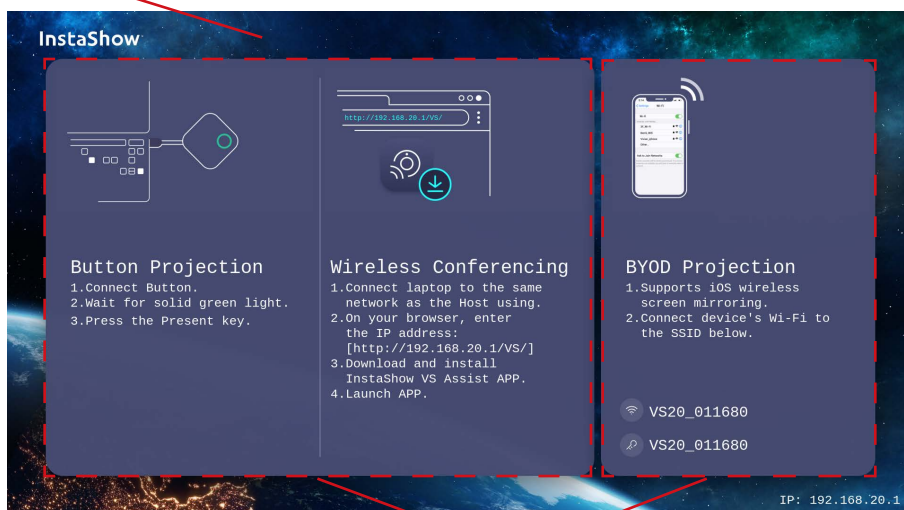

Tutorial Boxes

To customize the **Idle Screen** and/or **Guide Screen**:

1. Click the drop-down menu for either screen and then select **Customized**.
2. Click the **Select Image** button that appears.
3. Navigate to and select the image file on your local folder you want as either the Hosts **Guide Screen** or **Idle Screen**.
4. Click **Picture Upgrade** to switch the image to the you selected.



- To hide the tutorial boxes on either the **Guide Screen** or **Idle Screen**, check the **Tutorial Hide** box.
- To revert to the default **Guide Screen** or **Idle Screen**, select **Original** in the respective screen's field.

WAN

Click **WAN** and you can configure the settings for the Host's wired connection in the

General sub-menu.

General	
WAN Connection Type	Static IP
WAN IP Address	192.168.20.1 <input checked="" type="checkbox"/> Show In Screen
Subnet Mask	255.255.255.0
Default Gateway	0.0.0.0
DNS Server	0.0.0.0
DNS Relay	<input checked="" type="radio"/> On <input type="radio"/> Off

General

The **General** sub-menu includes the following configurable settings for the Host's connection to a network access point via the **WAN** port:

- **WAN Connection Type** - Select one of the following options to configure how the Host obtains the connection settings for its **WAN** connection, including IP address, subnet mask, and default gateway:
 - **DHCP** - This option allows the host to automatically acquire its configuration settings from the DHCP server of your network
 - **Static IP** - This option allows you to manually assign an IP address for the server.
 - **Repeater** - This option allows you to connect the Host to another Wi-Fi access point. See [Wi-Fi connection on page 23](#) for more information.
- **WAN IP Address** - When **WAN Connection Type** is set to **DHCP** or **Repeater** this field will list the Host's IP address, when **Static IP** is selected enter the IP address you want to assign to the Host.
- **Subnet Mask** - When **WAN Connection Type** is set to **DHCP** or **Repeater** this field will list the Host's subnet mask, when **Static IP** is selected enter the subnet mask you want to assign to the Host.
- **Default Gateway** - When **WAN Connection Type** is set to **DHCP** or **Repeater** this field will list the Host's default gateway, when **Static IP** is selected enter the default gateway you want to assign to the Host.
- **DNS Server** - Enter the Domain Name System (DNS) server for the Host in this field.
- **DNS Relay** - Select whether to enable or disable DNS relay in this field.

Press **Apply** to save any changes to the **General** fields.

Wireless Network

Click **Wireless Network** and you will see the **Setting, Wi-Fi Radio Setup**, and

Wireless Nodes Status sub-menus for the Host's wireless connection.

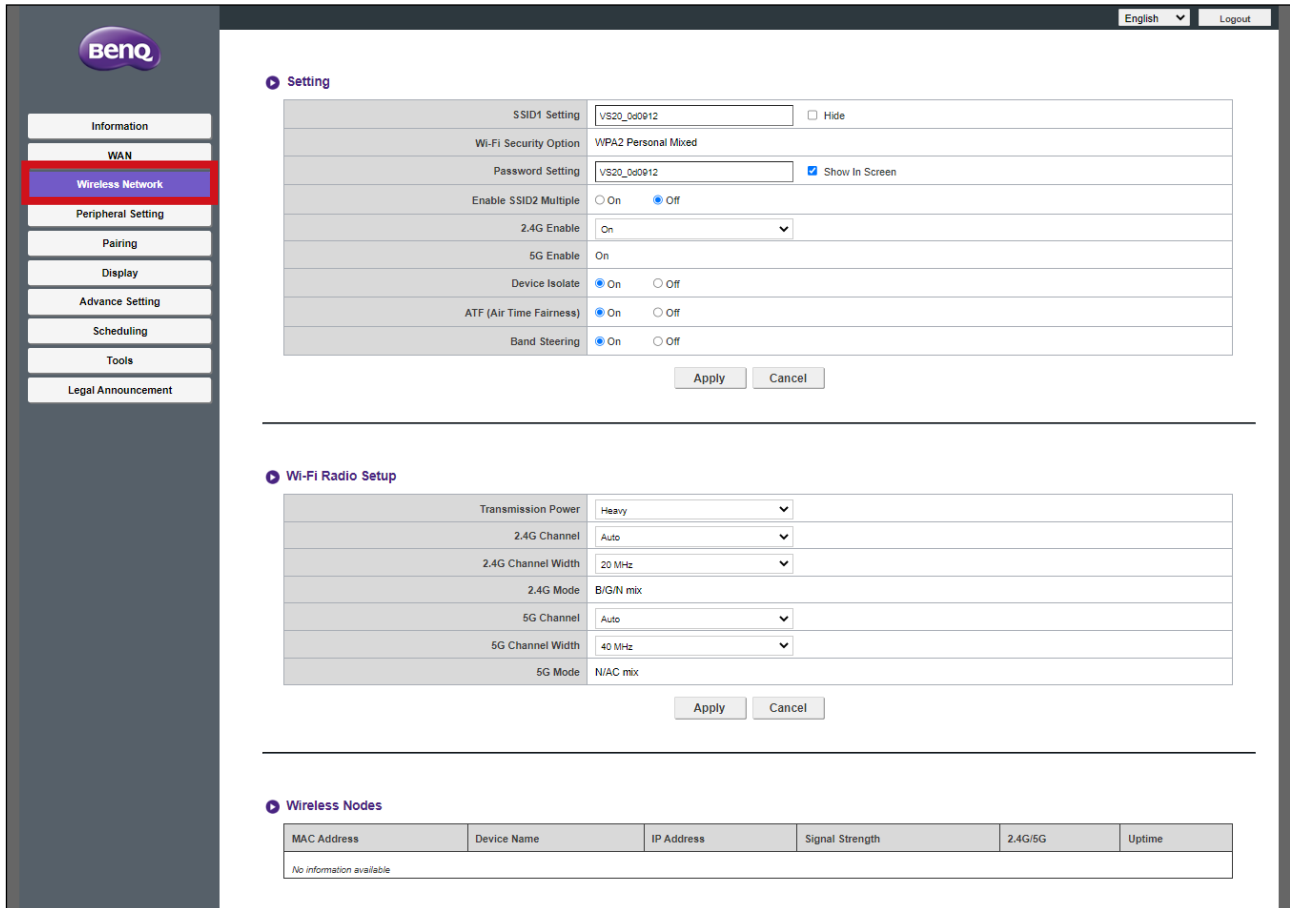

Setting

The **Setting** sub-menu includes the following basic settings for the Host's Wi-Fi signal:

- **SSID1 Setting** - This field allows you to customize the SSID (and **Room Name**) for the Host. Check **Hide** to make the Host's Wi-Fi signal undiscoverable by users.
- **Wi-Fi Security Option** - This field lists the Wi-Fi security for the Host's Wi-Fi signal.
- **Password Setting** - This field allows you to customize the password for the Host's SSID.
- **Enable SSID2 Multiple** - This option allows you to enable/disable an additional SSID for the Host. Once enabled the following options will become available:
 - **SSID2 Setting** - This field allows you to customize the second SSID for the Host.
 - **Wi-Fi Security Option** - This field lists the Wi-Fi security for the Host's Wi-Fi second signal. When set to **WPA2 Enterprise** you will be able to configure the **Radius Port**.
 - **Password Setting** - This field allows you to customize the password for the Host's second Wi-Fi signal/SSID.
- **2.4G Enable** - This option allows you to enable or disable a 2.4G frequency for the Host's Wi-Fi signal. A 2.4G Wi-Fi signal is a signal that features a larger coverage range but slower data speeds and is more commonly used by older mobile devices.
- **5G Enable** - This option cannot be disabled as all the connections between the Host and Buttons rely on 5G Wi-Fi.



-
- Certain mobile devices are unable to access 5G Wi-Fi signals due to hardware limitations. If your mobile device is unable to connect to the Host via Wi-Fi, select **Enable** in the **2.4G Enable** field.
 - Both **2.4G Enable** and **5G Enable** can be enabled at the same time.
-

- **Device Isolate** - This option when enabled allows you to block communication between the devices connected to the Host's network, including Buttons, PCs, and mobile devices as a security precaution.
- **ATF (Air Time Fairness)** - This option allows you to enable or disable ATF which allows faster clients to have more airtime than slower clients in order to boost the overall network performance. However, this may make slower clients even slower.
- **Band Steering** - This option allows you to enable or disable **Band Steering** which is a feature that balances dual-band capable wireless clients to connect to the faster 5GHz Wi-Fi, and leave the 2.4GHz Wi-Fi less-crowded for those clients who support 2.4GHz only in order to improve the Wi-Fi performance for all the clients. When using **Band Steering** you will only have one SSID ("VS20_XXXXXX") with one password to connect to.

Press **Apply** to save any change to the **Setting** fields.

Wi-Fi Radio Setup

The **Wi-Fi Radio Setup** sub-menu includes the following additional settings for the Host's Wi-Fi signal:

- **Transmission Power** - This field allows you to set the strength of the Wi-Fi signal with the following options:
 - **Heavy** - This option sets the Wi-Fi signal to a strong signal strength (10 dbm for 2.4G; 16 dbm for 5G).
 - **Standard** - This option sets the Wi-Fi signal to a standard signal strength (7 dbm for 2.4G; 13 dbm for 5G).
 - **ECO** - This option sets the Wi-Fi to a weaker, energy saving signal strength (1 dbm for 2.4G; 7 dbm for 5G).
- **2.4G Channel** - This field allows you to choose how the Host selects the wireless channel for its 2.4G signal. Select **Auto** to have the host select the 2.4G wireless channel with the best performance or manually select the channel that you want the signal to be set at.



-
- When **Auto** is selected in this field, the **5G Channel** will also automatically be switched to Auto. After switching, you can still manually change the **5G Channel** setting to another channel.
 - When a specific channel is selected in this field, the **5G Channel** will automatically be switched to its current channel. After switching, you can still manually change the **5G Channel** setting to another channel.
-

- **2.4G Channel Width** - This field allows you to choose either a **20MHz** or **40MHz** width for the 2.4G signal.
- **2.4G Mode** - This field lists the Wi-Fi standard for the 2.4G signal.
- **5G Channel** - This field allows you to choose how the Host selects the wireless channel for its 5G signal. Select **Auto** to have the host select the 5G wireless channel with the best performance or manually select the channel that you want the signal to be set at.



- When **Auto** is selected in this field, the **2.4G Channel** will also automatically be switched to Auto. After switching, you can still manually change the **2.4G Channel** setting to another channel.
- When a specific channel is selected in this field, the **2.4G Channel** will automatically be switched to its current channel. After switching, you can still manually change the **2.4G Channel** setting to another channel.

- **5G Channel Width** - This field allows you to choose either a **20MHz, 40MHz, or 80MHz** width for the 5G channel.
- **5G Mode** - This field lists the Wi-Fi standard for the 5G signal.



- The supported wireless channels listed vary according to wireless regulations of the country/region which is listed in the **Wi-Fi Area** field.
- The Wi-Fi standard for the Wi-Fi signal are set and cannot be configured.

Press **Apply** to save any change to the **Wi-Fi Radio Setup** fields.

Wireless Nodes Status

The **Wireless Nodes Status** sub-menu lists all the devices connected to the Host via Wi-Fi and indicates their **MAC Address, Device Name, IP Address, Wi-Fi channel used (2.4G/5G)**, and connection time (**Uptime**).

Peripheral Setting

Click **Peripheral Setting** and you will see the **Connected Device, Advance Setting, Selected VC Devices** and **VC Devices in Use** sub-menus for the Host.

The screenshot shows the BenQ web interface with the 'Peripheral Setting' menu item highlighted in the left sidebar. The main content area displays four sub-sections:

- Connected Device:** A table listing connected devices with columns for USB Port, Status, Vendor Code, Product Name, Description, and Testing.

USB Port	Status	Vendor Code	Product Name	Description	Testing
TX Wi-Fi Microphone	Connected	-	TX_Microphone	Audio	Microphone Test
Port 1	Connected	0x046d	BCC950_ConferenceCam	Video (1280x720x30fps)	Camera Test
Port 1	Connected	Logitech	BCC950_ConferenceCam	Audio	Microphone Test
Port 1	Connected	Logitech	BCC950_ConferenceCam	Speaker	Speaker Test
Port 2	Disconnected	None	-	None	
Port 3	Disconnected	None	-	None	
- Advance Setting:** A form with a dropdown menu for 'TX Wi-Fi Microphone' set to 'Enable', and 'Apply' and 'Cancel' buttons.
- Selected VC Devices:** A form with a dropdown menu for 'Strategy' set to 'Auto Meeting Audio', and 'Apply' and 'Cancel' buttons.
- VC Devices in Use:** A table showing the current configuration of devices.

Camera	USB1
Mic	TX Wi-Fi Microphone + USB1
Speaker	USB1

Connected Device

The **Connected Device** sub-menu lists the Host's USB ports (see image below for the respective listing for each port) and the corresponding peripheral devices (webcams, microphones, or speakers) connected to each of the Host's ports and its Wi-Fi signal (for InstaShow Buttons that are being used as microphones).

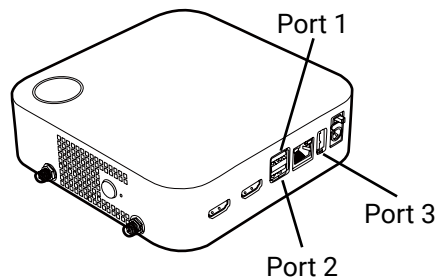

- For devices that have multiple functions, a separate listing will appear for each individual function. So, for example, a 3-in-1 webcam will feature three separate listings: one for the camera function, one for the microphone function, one for the speaker function.
- InstaShow Buttons that are used as microphones will be listed as **TX Wi-Fi Microphone**. For more information on using Buttons as microphones, see [Using multiple InstaShow Buttons as microphones on page 46](#).
- InstaShow Buttons connected to the Host for use as microphones are only listed in the **Connected Device** sub-menu when the **TX Wi-Fi Microphone** setting in the **Advance Setting** sub-menu is set to **Enable**.

For each device listed, the sub-menu also lists their connection status and relevant descriptions. Depending on the type of device connected, the **Testing** column may also include an option to test the various videoconferencing-related functions for the device:

- Click **Camera Test** to test if the camera on the device properly outputs video to the host. When clicked, a 5-second video preview will be displayed on the projector/display connected to the Host.
- Click **Microphone Test** to test if the microphone on the device or Button properly captures sound. When clicked, the screen displayed on the projector/display will turn grey for a few seconds, at that point speak into the corresponding microphone device and the Host will play back the audio shortly after.
- Click **Speaker Test** to test if the speakers on the device properly receives audio from the Host. When clicked, the test will consist of a few short beeps.

Advance Setting

The **Advance Setting** sub-menu allows you to enable/disable the **TX Wi-Fi Microphone** setting which allows you to use multiple InstaShow Buttons as videoconferencing microphones via the Host's Wi-Fi connection, see [Using multiple InstaShow Buttons as microphones on page 46](#) for more information.

Press **Apply** to save any change to the **Advance Setting** fields.

Selected VC Devices

The **Selected VC Devices** sub-menu includes the following settings that determine which of the Host's USB ports to use for any peripheral device (e.g. webcam, microphone, and speaker):

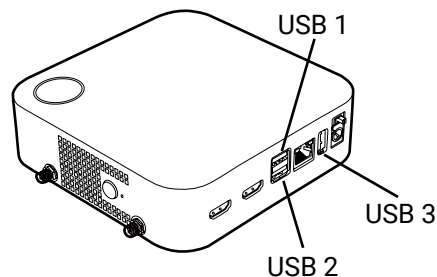

- **Strategy** - Set this field to **Auto Meeting Audio** to have the Host automatically scan its USB ports for the most optimal device (i.e. the device that supports the most videoconferencing-related functions combined in one) and use it as the default device for each respective function (camera, microphone, speaker).



- If there are no multi-function devices connected to the Host and **Auto Meeting Audio** is selected, the Host will select the first supporting device detected for the respective function.
- If **TX Wi-Fi Microphone** is enabled, the function will work in tandem with any microphone device connected to the Host's USB port.
- If multiple multi-function devices are connected to the Host at the same time, the Host will prioritize the devices based on the following criteria: (1) 3-in-1 webcam, (2) microphone and speaker combo, (3) other 2-in-1 combinations.

Set this field to **By User Preference** to manually designate either which USB port that the Host will use for each type of videoconferencing-related function. Once **By User Preference** is selected the following list of functions will appear for you to designate a port or to exclude from use:

- **Camera** - Designate the USB port which the webcam must be connected to in order to be used or choose to disable the use of a webcam in this field.
- **Mic** - When the **TX Wi-Fi Microphone** setting in the **Advance Setting** sub-menu is enabled, designate the USB port that the device must be connected to in order to be used as a microphone in tandem with any InstaShow Buttons connected via the Host's Wi-Fi signal in this field.
When the **TX Wi-Fi Microphone** setting in the **Advance Setting** sub-menu is disabled designate only the USB port that the device must be connected to in order to be used as a microphone in this field.
Choose **Disable** to disable the connection of any external microphone device for the Host.
- **Speaker** - Designate the USB port which the device must be connected to in order to be used as a speaker or choose to disable the use of an external speaker in this field.

Press **Apply** to save any change to the **Selected VC Devices** fields.

VC Devices in Use

The **VC Devices in Use** sub-menu lists the port(s) and/or InstaShow Button designated for use for each videoconferencing-related function (camera, microphone, speaker) based on the settings selected in the **Advance Setting** and **Selected VC Devices** sub-menu.

Pairing

Click **Pairing** and you will see **Pairing** and **Pairing Status** sub-menus.

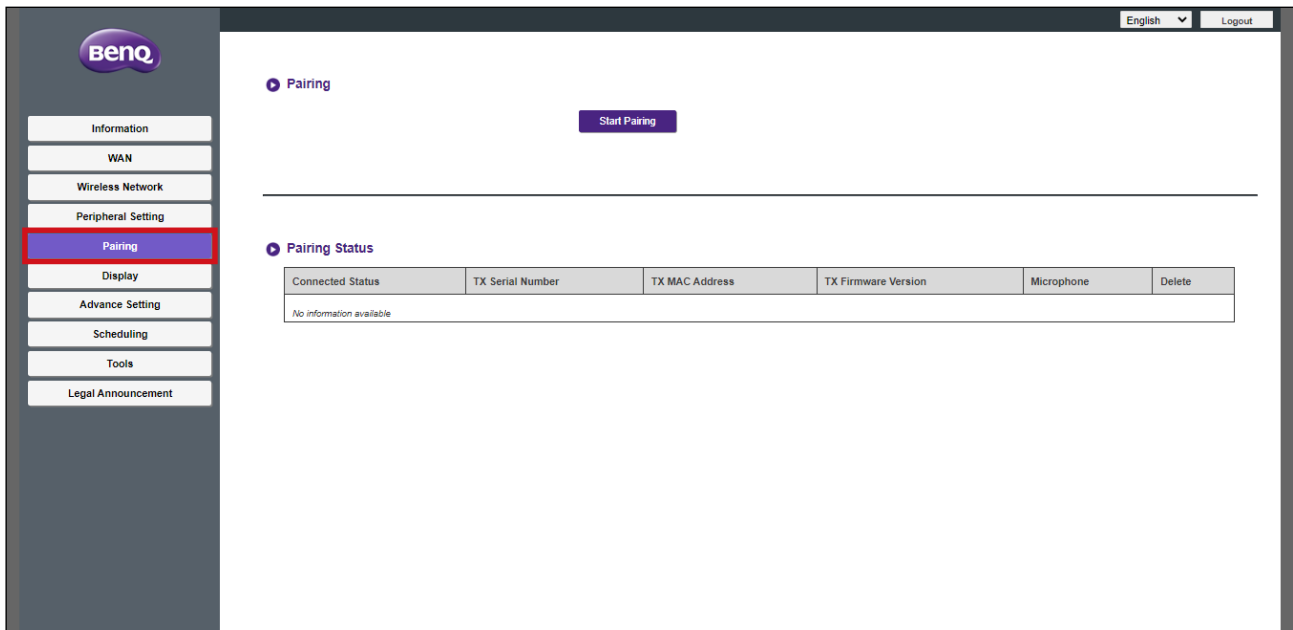

Pairing

The **Pairing** submenu can be used when the Host is attached to the ceiling as it is not easy to press the **PAIRING** key of the Host when the device is too high. To pair a Button and Host via the web management interface:

1. Connect the Button's USB connector to the corresponding ports of a laptop.

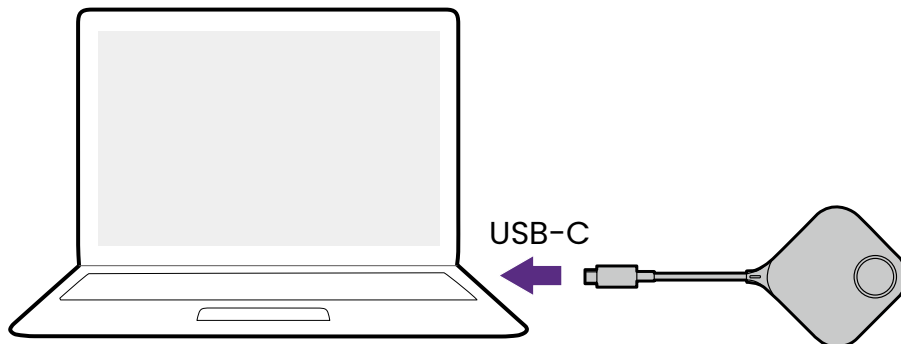

2. When the Button is successfully connected to the laptop, the LED indicator of the Button will blink green.

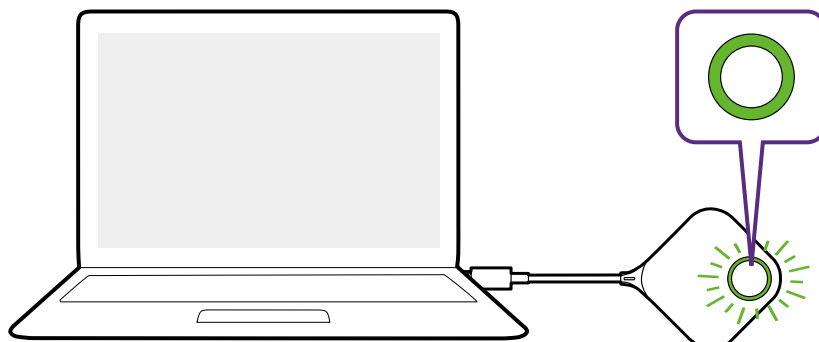

3. Make sure the Host is properly connected to a power source.
4. Press **Start pairing** to pair the Host to the Button via the web management interface, you will have two minutes to pair with the Button.

Pairing

Start pairing

5. Press the split screen key on the side of the Button for five seconds. The LED indicator of the Button will blink blue for about 10 seconds. The pairing process is ongoing. A **"Pairing in progress"** message will be shown on the screen.

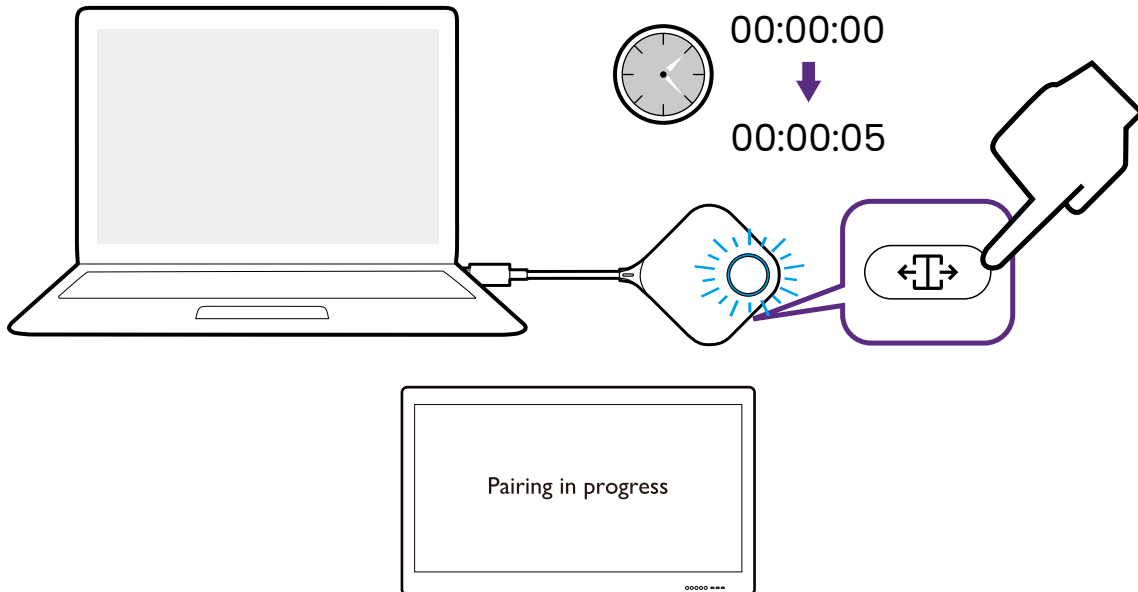

6. The LED indicator of the Button will turn static green when the Host and Button are successfully paired.

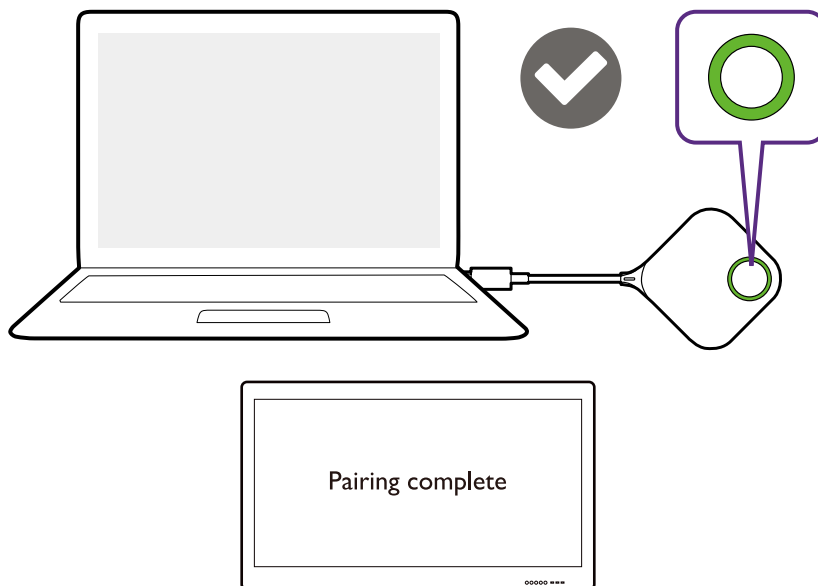

- Images are for reference only. Each product features a different serial number.
- The maximum number of Buttons you can pair with one Host is 32.

7. You may press **Stop pairing** anytime to stop the pairing process.

▶ Pairing

Stop pairing

Pairing remaining time: 104s

Pairing Status

The **Pairing Status** sub-menu lists all the Buttons that are already paired to the Host.

Display

Click **Display** and you will see the **Display Output Setting** sub-menu.

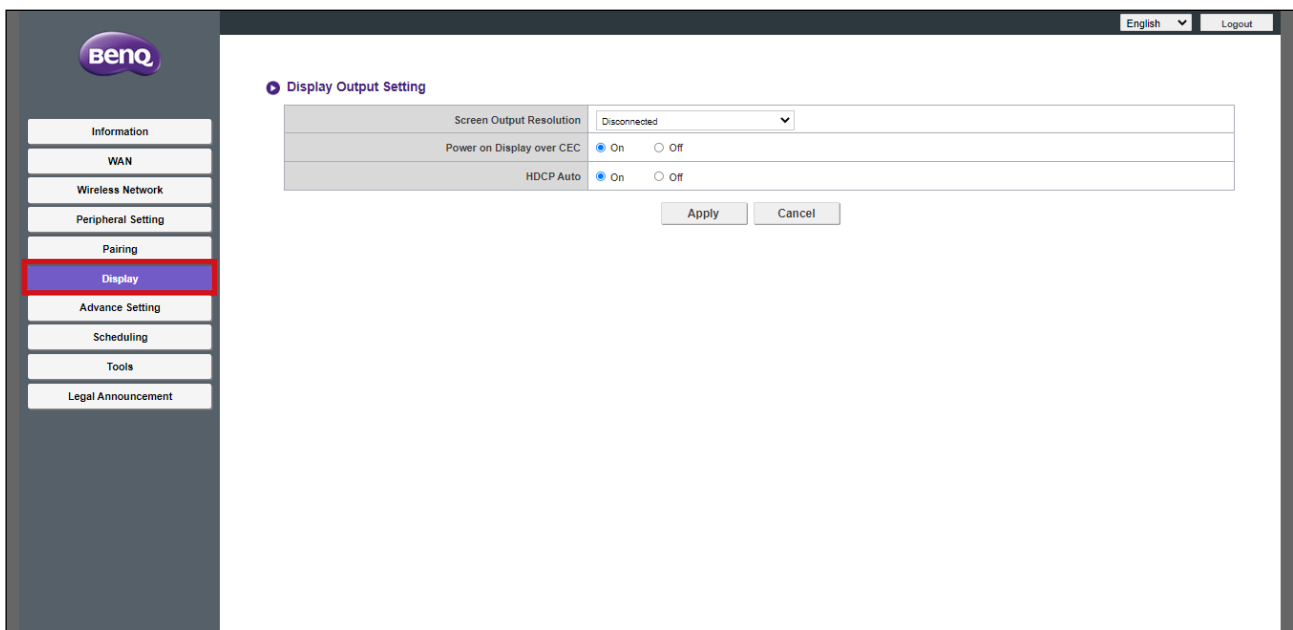

Display Output Setting

The **Display Output Setting** sub-menu includes the following settings for the video output by the Host to the display connected to its **HDMI OUT** port:

- **Screen Output Resolution** - This settings configures the output resolution for the video broadcast by the Host. When **Screen Output Resolution** is set to **Auto** the Host will select the output resolution based on the connected display's native specifications, or you can select an output resolution manually.
- **Power on Display over CEC** - When this setting is enabled, the display connected to the Host's **HDMI OUT** port will automatically power on whenever the Host is powered on.
- **HDCP Auto** - This setting allows you to configure whether or not High-bandwidth Digital Content Protection (HDCP) is automatically enabled for the content output by the Host. When set to **On** the HDCP copy protection will be automatically enabled by the Host for content that features HDCP copy protection and disabled for content that does not feature HDCP copy protection. When set to **Off** the HDCP copy protection will always be enabled by the Host.

Press **Apply** to save any change to the **Display Output Setting** fields.

Advance Setting

Click **Advance Setting** and you will see the **Advance Setting**, **Firewall**, **Network Service**, **Restart**, and **Power Saving** sub-menus.

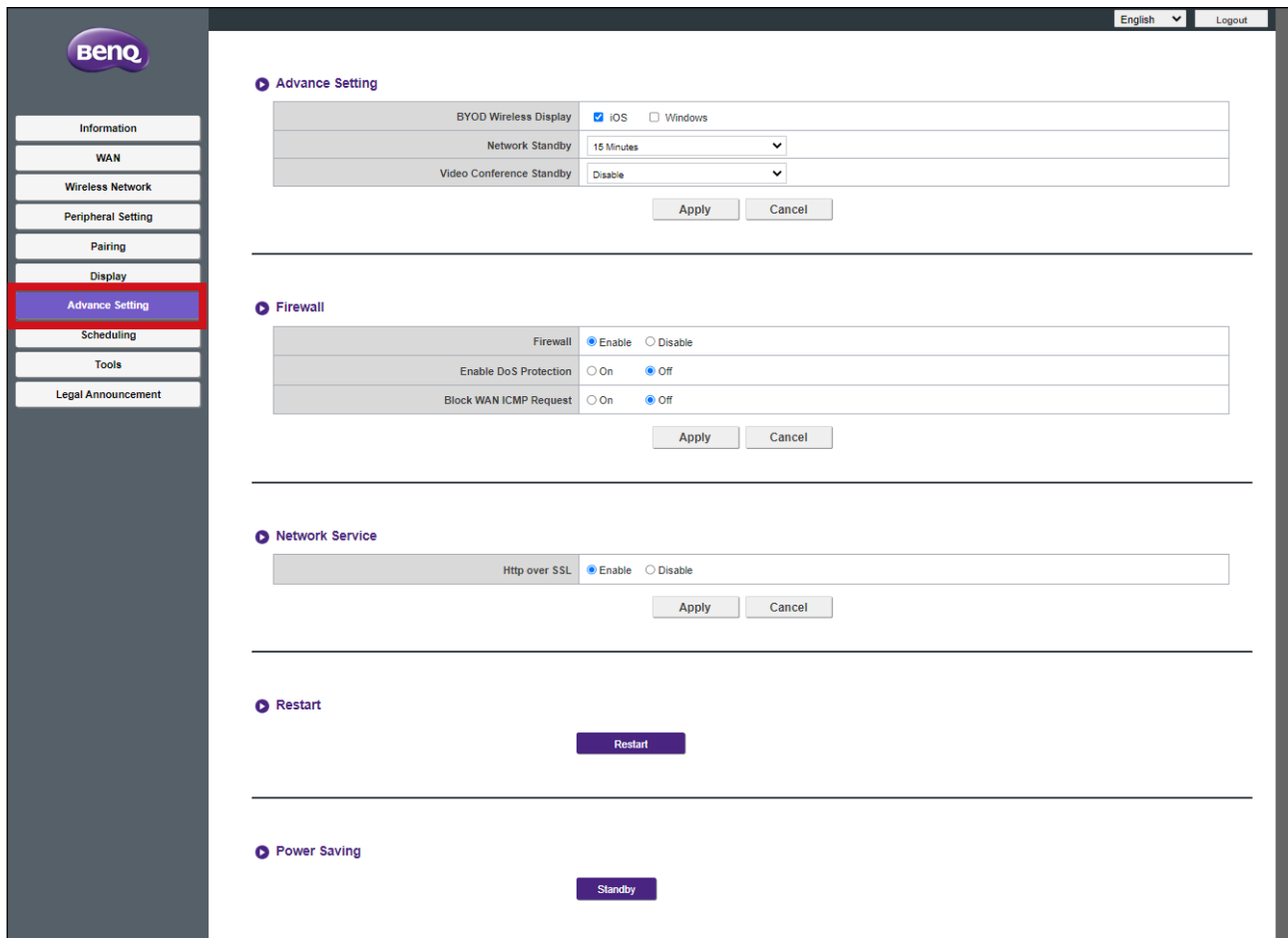

Advance Setting

The **Advance Setting** sub-menu includes the following advanced setting for the Host:

- **BYOD Wireless Display** - This setting allows you to permit or prohibit iOS and Windows mobile devices from presenting via the Host. Check the box next to an operating system to allow devices using the respective operating system to present.



By default the **Windows** option will be disabled (unchecked).

- **Network Standby** - This setting allows you to set the amount of idle time before the host enters network standby mode. Once in network standby mode the user will have to re-enter the login and password for the web management menu to continue.
- **Video Conference Standby** - This setting when enabled allows you to automatically hide the InstaShow window from videoconferencing interface anytime InstaShow is not presenting thus allowing the videoconferencing application to save screen space when InstaShow is not directly in use. The InstaShow window will still appear within the videoconferencing interface on command anytime the Button is pushed and a presentation via the Host begins.

Press **Apply** to save any change to the **Advance Setting** fields.

Firewall

The **Firewall** sub-menu includes the following settings for the Host's firewall:

- **Firewall** - This setting allows you to enable the Host's built-in firewall.
- **Enable DoS Protection** - This settings allows you to enable the Host's built-in Denial of Service (DoS) protections. DoS attacks are attacks that intend to deny users from using a network by flooding the network with artificial traffic that slows down the network to a degree to which it is unusable.
- **Block WAM ICMP Request** - This setting allows you to block Internet Control Message Protocol (ICMP) requests, which is a type of network communication that is commonly used in DoS-type of attacks.

Press **Apply** to save any change to the **Firewall** fields.

Network Service

The **Network Service** sub-menu allows you to enable **Http over SSL** which adds SSL security to the connection between the device accessing the web management menu and the Host. When enabled the URL used to access the menu requires an "HTTPS://" prefix.

Restart

Click the **Restart** button to restart the Host.

Power Saving

The **Power Saving** sub-menu allows you to put the Host in **Standby** mode when it is active, or **Wakeup** the Host from **Standby** mode.

Scheduling

Click **Scheduling** and you will see the **System Time** and **Scheduler** sub-menus.

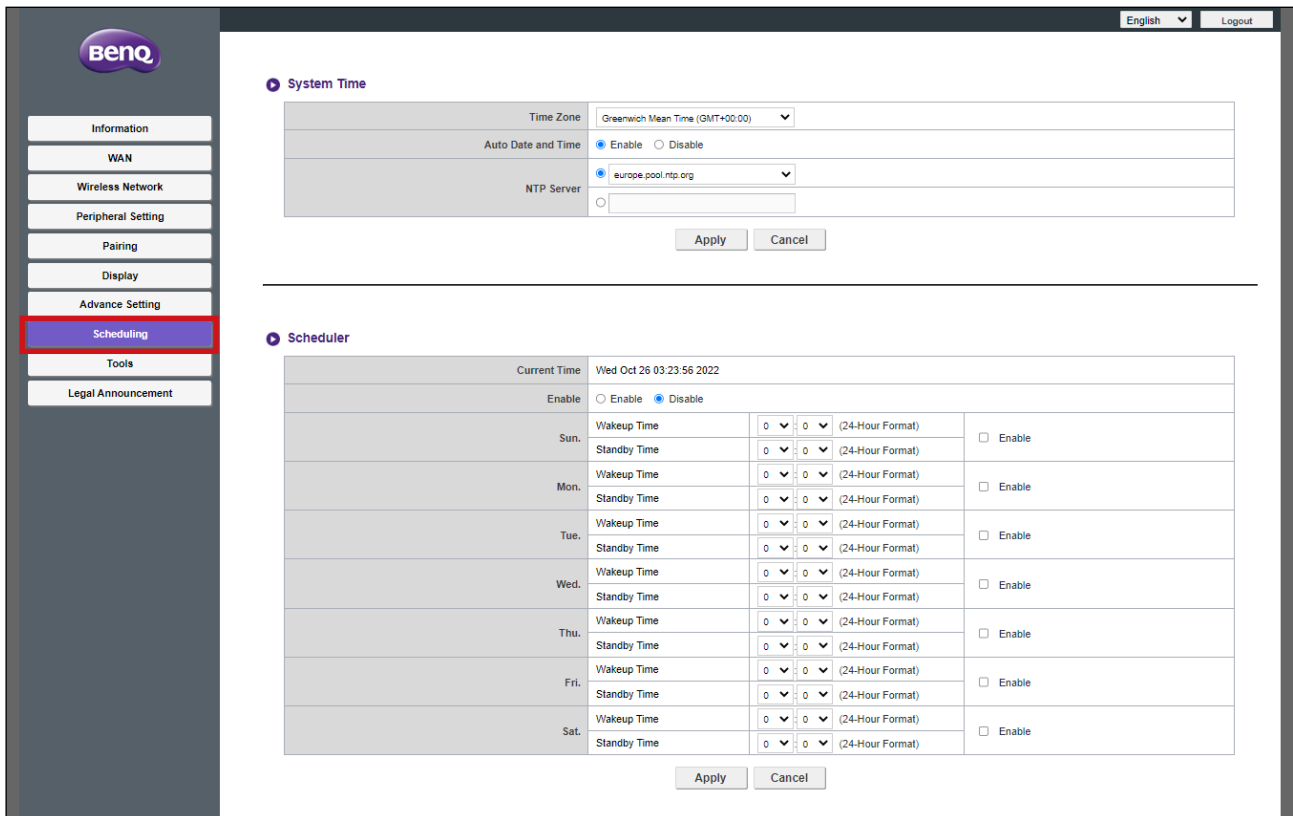

System Time

The **System Time** sub-menu includes the following time settings for the Host:

- **Time Zone** - This field allows you to select the time zone for the Host.
- **Auto Date and Time** - Select whether you want the Host to automatically retrieve the date and time from the Internet in this field. When set to **Disable**, you can manually set the **Date** and **Time**. The time settings will be saved to internal memory accordingly.
- **NTP Server** - When **Auto Date and Time** is set to **Enable** enter the server from which the time is obtained in this field.

Press **Apply** to save any change to the **System Time** fields.

Scheduler

The **Scheduler** sub-menu allows you to set times for when the Host will automatically wake up or enter standby on any day of the week. To set up the **Scheduler**:

1. Check **Enable**.
2. Check **Enable** for the day(s) in which you want the scheduler to be active.
3. Select the **Wakeup Time** for the corresponding day.
4. Select the **Standby Time** for the corresponding day.

5. Click **Apply** to save the schedule.

Scheduler

Current Time: Wed Oct 26 03:23:56 2022

Enable Disable

Day	Wakeup Time	Standby Time	(24-Hour Format)	Enable
Sun.	0	0	(24-Hour Format)	<input type="checkbox"/>
Mon.	0	0	(24-Hour Format)	<input type="checkbox"/>
Tue.	0	0	(24-Hour Format)	<input type="checkbox"/>
Wed.	0	0	(24-Hour Format)	<input type="checkbox"/>
Thu.	0	0	(24-Hour Format)	<input type="checkbox"/>
Fri.	0	0	(24-Hour Format)	<input type="checkbox"/>
Sat.	0	0	(24-Hour Format)	<input type="checkbox"/>

Tools

Click **Tools** to see the **Password Setup**, **Firmware Upgrade**, **Configuration Management**, **Wi-Fi Traffic Test**, and **Log Setting** tools/sub-menus.

BENQ

English Logout

- Information
- WAN
- Wireless Network
- Peripheral Setting
- Pairing
- Display
- Advance Setting
- Scheduling
- Tools**
- Password Setup
- Firmware Upgrade
- Configuration Management
- Wi-Fi Traffic Test
- Log Setting
- Legal Announcement

Please input the old password Show Password

Please input the new password Show Password

Please input the password again Show Password

Password Setup

The **Password Setup** allows you to change the **Password** for the web management menu. To change the password:

1. Enter your old password.
2. Enter the new password.
3. Enter the new password again to confirm your new password.

4. Press **Reset** to save the password.

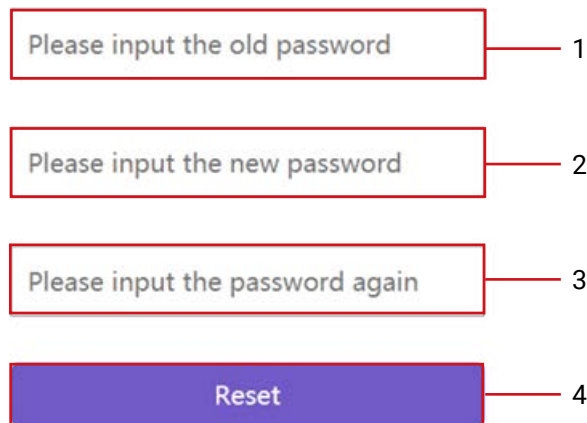

Firmware Upgrade

The **Firmware Upgrade** sub-menu allows you to check for and execute firmware upgrades for both the Host (via the **Host(RX) Firmware Upgrade** sub-menu) and Button (via the **Button(TX) Firmware Upgrade** sub-menu).

Before checking for a new firmware upgrade for your Host or Button, first ensure that the Host is connected to a router with access to the Internet. For upgrades to the Button's firmware also ensure that the Button is paired and connected to the Host.

The screenshot displays the BenQ web interface with the Firmware Upgrade sub-menu highlighted in the left sidebar. The main content area shows two sub-menus:

- Host(RX) Firmware Upgrade**: Includes fields for Firmware Version (VS20(R)_0.48), New Host Firmware Version on OTA Server (VS20(R)_0.48), and Firmware File (From a Local File selected). A **New Firmware Check** button and a **Periodical Check** checkbox are also present.
- Button(TX) Firmware Upgrade**: Includes fields for New Button Firmware Version on OTA Server, Firmware File (From a Local File selected), and From Host(RX) and From OTA Server options. A **New Firmware Check** button and a **Periodical Check** checkbox are also present.

A warning message is displayed at the bottom:

Warning
Don't power off or press the reset button during the process of firmware upgrading.
Don't close the window during the process of firmware upgrading.

To check if firmware upgrades are available for the Host and/or Button click the **New Firmware Check** button in the respective sub-menu for the device.

Host(RX) Firmware Upgrade

OTA	<input type="button" value="New Firmware Check"/> <input checked="" type="checkbox"/> Periodical Check
Firmware Version	VS20(R)_0.48
New Host Firmware Version on OTA Server	VS20(R)_0.48
Firmware File	<input type="radio"/> From OTA Server <input checked="" type="radio"/> From a Local File <input type="button" value="Select File"/>
Upgrade InstaShow Host	<input type="button" value="Firmware Upgrade"/>

Button(TX) Firmware Upgrade

OTA	<input type="button" value="New Firmware Check"/> <input checked="" type="checkbox"/> Periodical Check
New Button Firmware Version on OTA Server	
Firmware File	<input checked="" type="radio"/> From a Local File <input type="button" value="Select File"/> <input type="radio"/> From Host(RX) <input type="radio"/> From OTA Server
Upgrade Selected InstaShow Button	<input type="button" value="Firmware Upgrade"/> 70:F7:54:88:7E:8C VS20(T)_0.44



- To have the Host or Button periodically check for firmware upgrades check the **Periodical Check** box in the respective sub-menu for the device.
- Periodic checks for upgrades can only occur when the Host is connected via the WAN port to a router with access to the Internet.

Host(RX) Firmware Upgrade

If a new firmware upgrade is available the new firmware version will be listed in the **New Host Firmware Version on OTA Server** field.

To perform an OTA upgrade of the Host's firmware:

1. Select **From OTA Server** in the **Firmware File** field.
2. Click the **Firmware Upgrade** button in the **Upgrade InstaShow Host** field.

Host(RX) Firmware Upgrade

OTA	<input type="button" value="New Firmware Check"/> <input checked="" type="checkbox"/> Periodical Check
Firmware Version	VS20(R)_0.48
New Host Firmware Version on OTA Server	VS20(R)_0.48
Firmware File	<input checked="" type="radio"/> From OTA Server <input type="radio"/> From a Local File <input type="button" value="Select File"/>
Upgrade InstaShow Host	<input type="button" value="Firmware Upgrade"/>



To perform an OTA upgrade ensure that the Host is connected to a router with access to the Internet.



When performing any type of upgrade, DO NOT do any of the following:

- Power off or press the reset button on the Host or Button.
- Close the browser window of the web management interface.

Failure to follow these warnings will result in firmware upgrade failure and subsequent product failure.

To perform a direct upgrade from an upgrade file located on your local computer follow the steps below:



Before executing a direct firmware upgrade, please contact your BenQ regional office for access to the upgrade files.

1. Select **From a Local File** and then click the **Select File** button in the **Firmware File** field.

Host(RX) Firmware Upgrade

OTA	<input type="button" value="New Firmware Check"/>	<input checked="" type="checkbox"/> Periodical Check
Firmware Version	VS20(R)_0.48	
New Host Firmware Version on OTA Server	VS20(R)_0.48	
Firmware File	<input type="radio"/> From OTA Server <input checked="" type="radio"/> From a Local File <input type="button" value="Select File"/>	
Upgrade InstaShow Host	<input type="button" value="Firmware Upgrade"/>	

2. Navigate to and select the firmware upgrade file.

3. Click the **Firmware Upgrade** button in the **Upgrade InstaShow Host** field.

Host(RX) Firmware Upgrade

OTA	<input type="button" value="New Firmware Check"/>	<input checked="" type="checkbox"/> Periodical Check
Firmware Version	VS20(R)_0.48	
New Host Firmware Version on OTA Server	VS20(R)_0.48	
Firmware File	<input type="radio"/> From OTA Server <input checked="" type="radio"/> From a Local File <input type="button" value="Select File"/> firmware_upg...S20_1.20.zip	
Upgrade InstaShow Host	<input type="button" value="Firmware Upgrade"/>	



When performing any type of upgrade DO NOT do any of the following:

- Power off or press the reset button on the Host or Button.
- Close the browser window of the web management interface.

Failure to follow these warnings will result in firmware upgrade failure and subsequent product failure.

Button(TX) Firmware Upgrade

To upgrade the Button's firmware using an upgrade file located on your local computer follow the steps below:

1. Connect the Button you want to upgrade to the laptop running the web management interface and then wait for the Button's LED indicator to light up green.

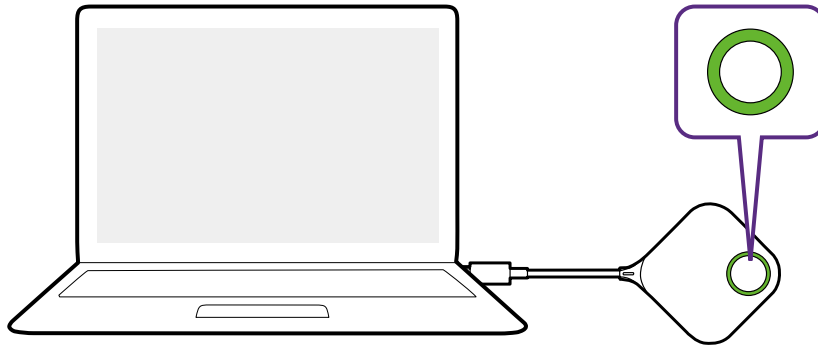

2. Select **From a Local File** in the **Firmware File** field and then click the **Select File** button.

Button(TX) Firmware Upgrade

OTA	<input type="button" value="New Firmware Check"/>	<input checked="" type="checkbox"/> Periodical Check
New Button Firmware Version on OTA Server		
Firmware File	<input checked="" type="radio"/> From a Local File <input type="button" value="Select File"/>	
	<input type="radio"/> From Host(RX)	
	<input type="radio"/> From OTA Server	
Upgrade Selected InstaShow Button	<input type="button" value="Firmware Upgrade"/>	
	70:F7:54:88:7E:8C VS20(T)_0.44	

3. Navigate to and select the firmware upgrade file.

4. Select the Button you want to upgrade and then click the **Firmware Upgrade** button in the **Upgrade Selected InstaShow Button** field.

Button(TX) Firmware Upgrade

OTA	<input type="button" value="New Firmware Check"/>	<input checked="" type="checkbox"/> Periodical Check
New Button Firmware Version on OTA Server		
Firmware File	<input checked="" type="radio"/> From a Local File <input type="button" value="Select File"/> firmware_upg...S20_1.20.zip	
	<input type="radio"/> From Host(RX)	
	<input type="radio"/> From OTA Server	
Upgrade Selected InstaShow Button	<input type="button" value="Firmware Upgrade"/>	
	70:F7:54:88:7E:8C VS20(T)_0.44	



When performing any type of upgrade DO NOT do any of the following:

- Power off or press the reset button on the Host or Button.
- Close the browser window of the web management interface.

Failure to follow these warnings will result in firmware upgrade failure and subsequent product failure.

To upgrade the Button's firmware directly from your Host via the connection between the Button and Host.

1. Connect the Button you want to upgrade to a laptop and then wait for the Button to link up with the Host and the LED indicator to light up green.

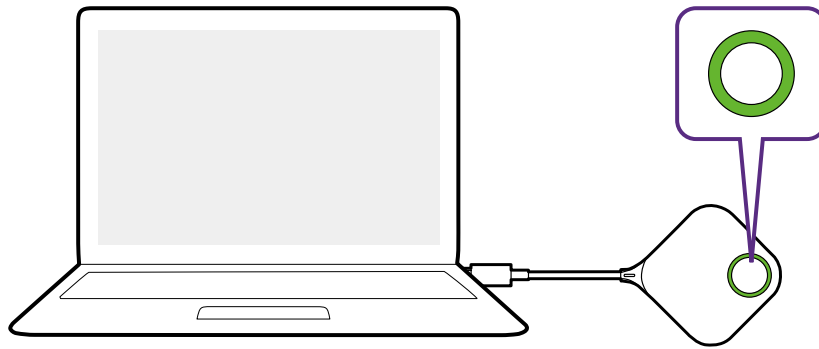

2. Select **From Host(RX)** in the **Firmware File** field.

Button(TX) Firmware Upgrade

OTA	New Firmware Check	<input checked="" type="checkbox"/> Periodical Check
New Button Firmware Version on OTA Server		
Firmware File	<input type="radio"/> From a Local File Select File <input checked="" type="radio"/> From Host(RX) <input type="radio"/> From OTA Server	
Upgrade Selected InstaShow Button	Firmware Upgrade	70:F7:54:88:7E:8C VS20(T)_0.44

3. Select the Button you want to upgrade and then click the **Firmware Upgrade** button in the **Upgrade Selected InstaShow Button** field.

Button(TX) Firmware Upgrade

OTA	New Firmware Check	<input checked="" type="checkbox"/> Periodical Check
New Button Firmware Version on OTA Server		
Firmware File	<input type="radio"/> From a Local File Select File <input checked="" type="radio"/> From Host(RX) <input type="radio"/> From OTA Server	
Upgrade Selected InstaShow Button	Firmware Upgrade	70:F7:54:88:7E:8C VS20(T)_0.44



When performing any type of upgrade DO NOT do any of the following:

- Power off or press the reset button on the Host or Button.
- Close the browser window of the web management interface.
- The button of Firmware Upgrade becomes gray out when the version in Button is newer than the version in Host.

Failure to follow these warnings will result in firmware upgrade failure and subsequent product failure.

If a new firmware upgrade via OTA is available the new firmware version will be listed in the **New Button Firmware Version on OTA Server** field. To perform an OTA upgrade for the Button follow the steps below:



To perform an OTA upgrade ensure that the Host is connected to a router with access to the Internet.

1. Connect the Button you want to upgrade to the laptop running the web management interface and then wait for the Button to link up with the Host and the LED indicator to light up green.

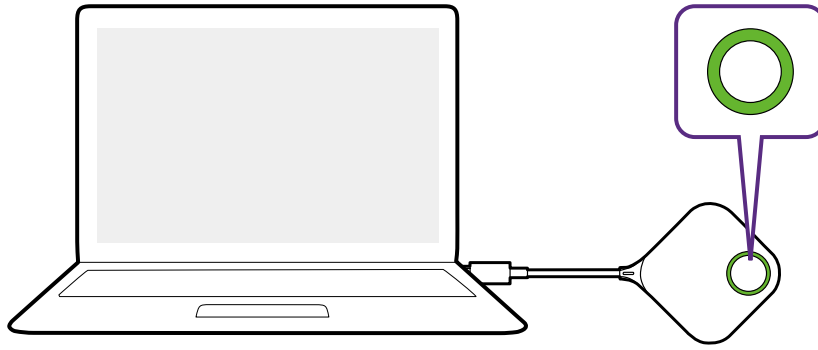

2. Select **From OTA Server** in the **Firmware File** field.

Button(TX) Firmware Upgrade

OTA	New Firmware Check	<input checked="" type="checkbox"/> Periodical Check
New Button Firmware Version on OTA Server		
Firmware File	<input type="radio"/> From a Local File <input type="button" value="Select File"/> <input type="radio"/> From Host(RX) <input checked="" type="radio"/> From OTA Server	
Upgrade Selected InstaShow Button	Firmware Upgrade 70:F7:54:88:7E:8C VS20(T)_0.44	

3. Select the Button you want to upgrade and then click the **Firmware Upgrade** button in the **Upgrade Selected InstaShow Button** field.

Button(TX) Firmware Upgrade

OTA	New Firmware Check	<input checked="" type="checkbox"/> Periodical Check
New Button Firmware Version on OTA Server		
Firmware File	<input type="radio"/> From a Local File <input type="button" value="Select File"/> <input type="radio"/> From Host(RX) <input checked="" type="radio"/> From OTA Server	
Upgrade Selected InstaShow Button	Firmware Upgrade 70:F7:54:88:7E:8C VS20(T)_0.44	

To perform an OTA upgrade ensure that the Host is connected via the WAN port to a router with access to the Internet and the Button is paired and connected to the Host.

When performing any type of upgrade DO NOT do any of the following:

- Power off or press the reset button on the Host or Button.
- Close the browser window of the web management interface.

Failure to follow these warnings will result in firmware upgrade failure and subsequent product failure.

Configuration Management

Configuration backup files feature the configuration settings for your Host except for the host name, SSID and wireless password settings, and pairing status. In **Configuration Management**, you can choose **Import Configuration File**, **Export Complete Configuration File**, and **Factory Default**.

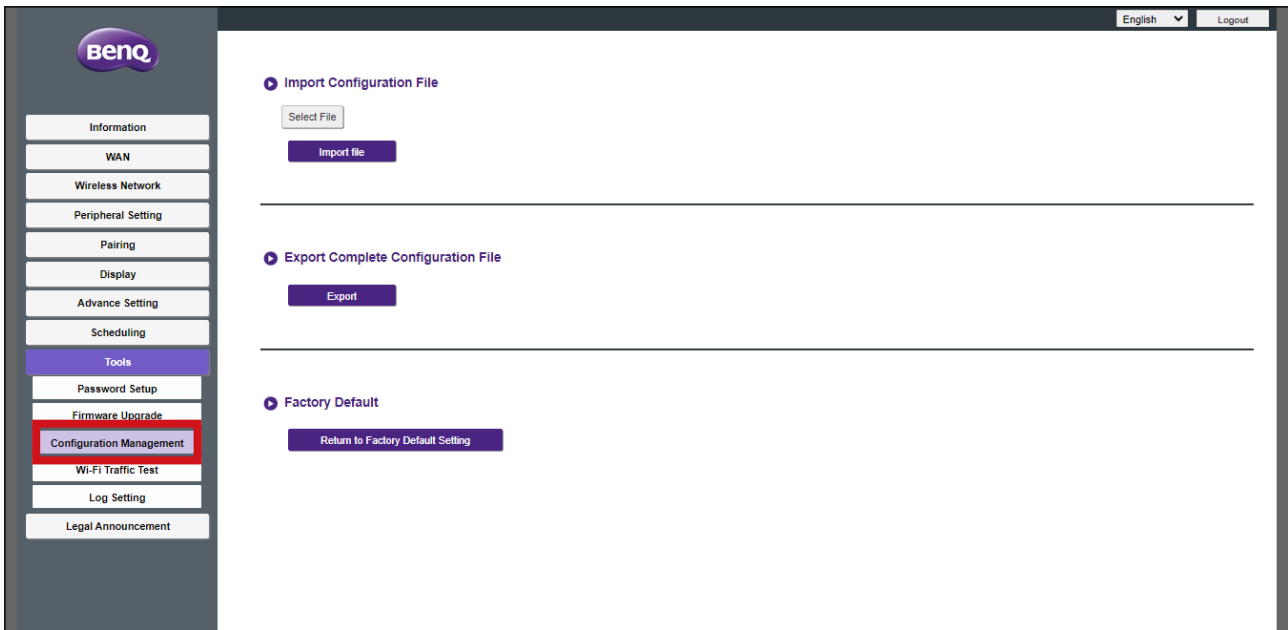

You can import configurations files by:

1. Clicking **Select File** in the **Import Configuration File** sub-menu.

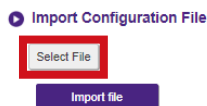

2. Navigating to and selecting the configuration file you want to import from your local computer.

3. Clicking **Import File** to choose the file to import.

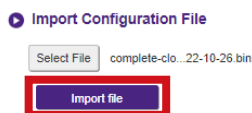

You can export a full configuration backup in the **Export Complete Configuration File** sub-menu by:

1. Clicking **Export**.

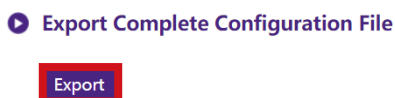

2. Navigating to the folder you want to save the backup file to in your local computer and then choosing **Save**.



The exported configuration file can only be imported by the same Host that exported the file. The configuration file cannot be imported by any other Hosts.

You can have the Host restore to **Factory Default** by clicking **Return to Factory Default Setting**.

Factory Default

Return to Factory Default Setting

When the process is confirmed the Host will begin restoring to **Factory Default** and the LED will quick flash red (flash red twice every second) then restart. After the Host restarts the entire process is complete.

Wi-Fi Traffic Test

The **Wi-Fi Traffic Test** sub-menu allow you to test the speed of the connection between your Host and the Button.

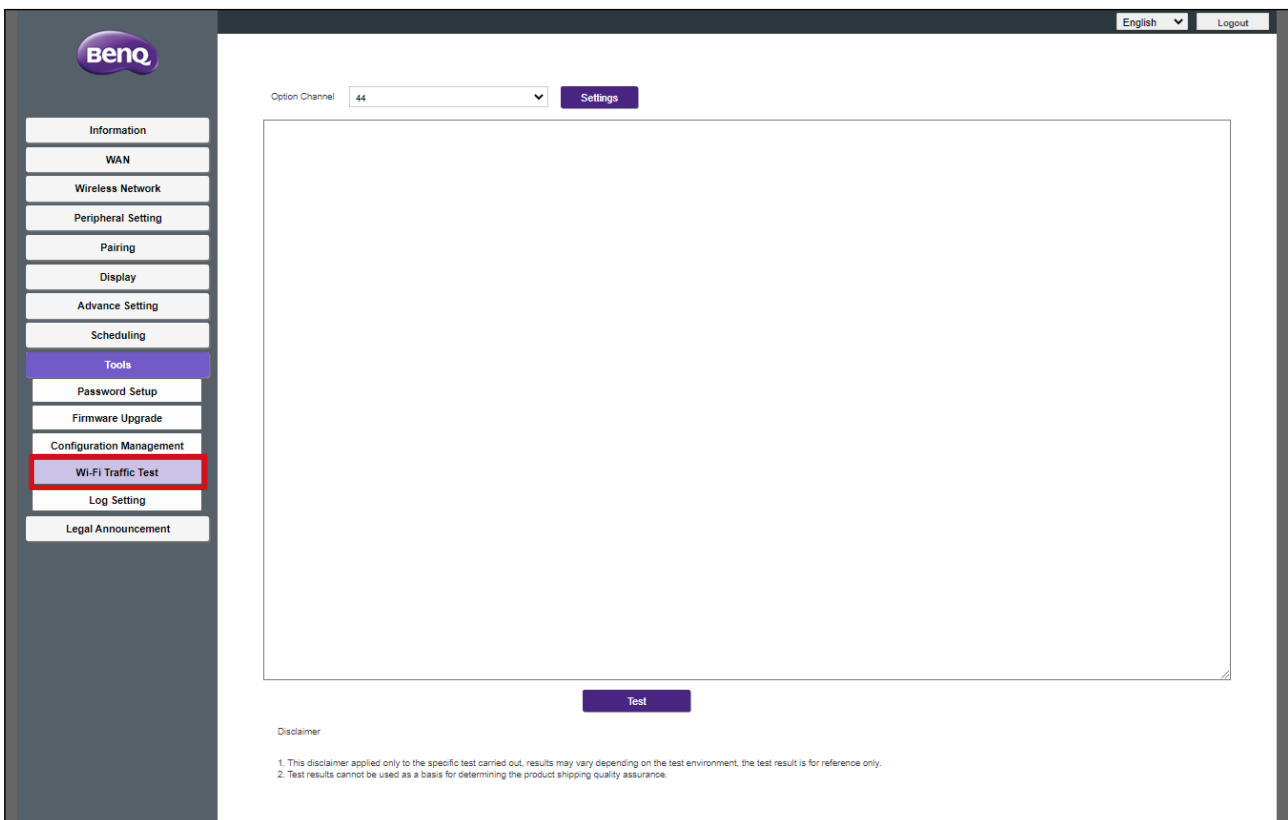

To test the speed of the connection follow the steps below:

1. Select the Button you want to test the connection speed for in the **Option Button** field.

Option Button: 70.F7.54.88.7E.9C / 192.168.168.3 [Settings]

Option Channel: 44 [Settings]

Test

Disclaimer

1. This disclaimer applied only to the specific test carried out, results may vary depending on the test environment, the test result is for reference only.
2. Test results cannot be used as a basis for determining the product shipping quality assurance.

2. Click the **Settings** button in the **Option Button** field.

Option Button: 70.F7.54.88.7E.9C / 192.168.168.3 [Settings]

Option Channel: 44 [Settings]

Test

Disclaimer

1. This disclaimer applied only to the specific test carried out, results may vary depending on the test environment, the test result is for reference only.
2. Test results cannot be used as a basis for determining the product shipping quality assurance.

3. Select the channel you want to test the speed of in the **Option Channel** field.

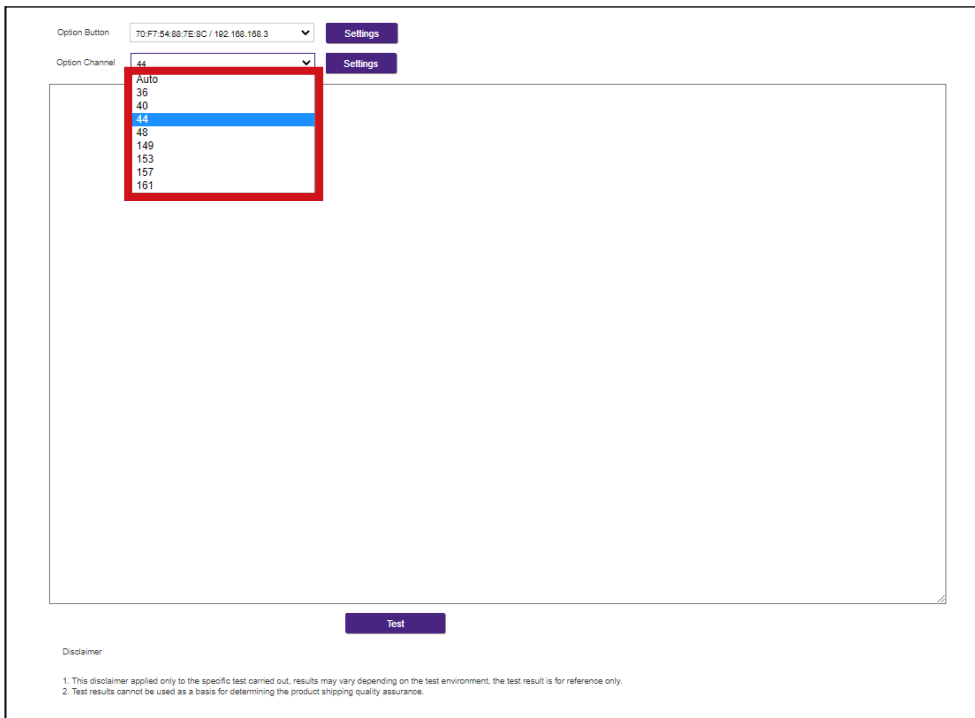

4. Click the **Settings** button to set the channel test.

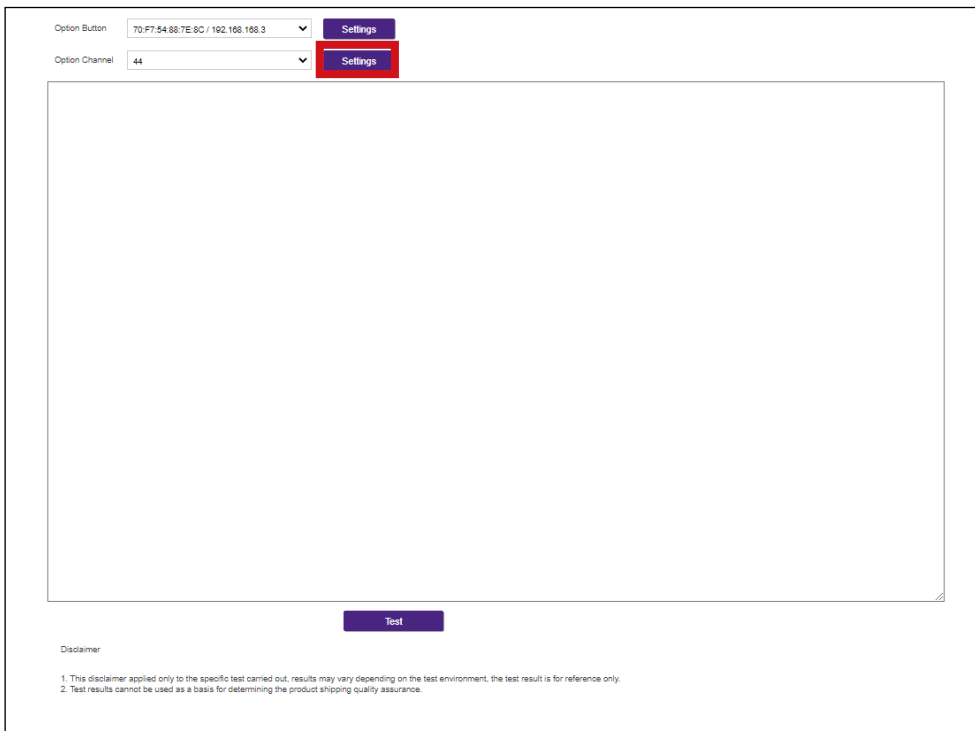

5. Click the **Test** button. The results of the test will be shown in the main window.

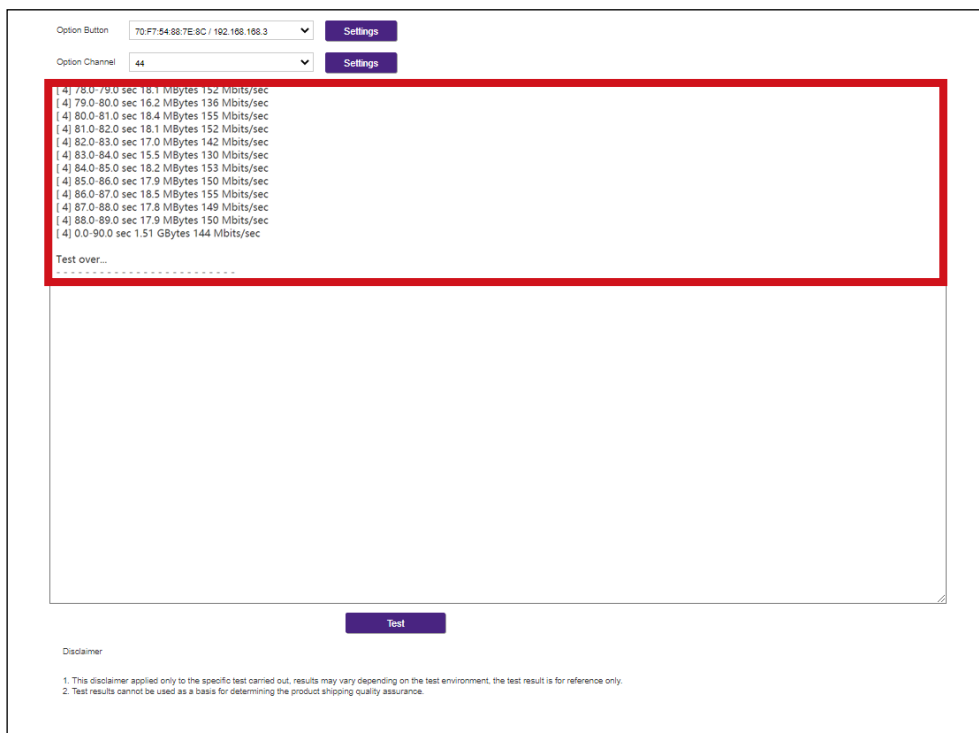
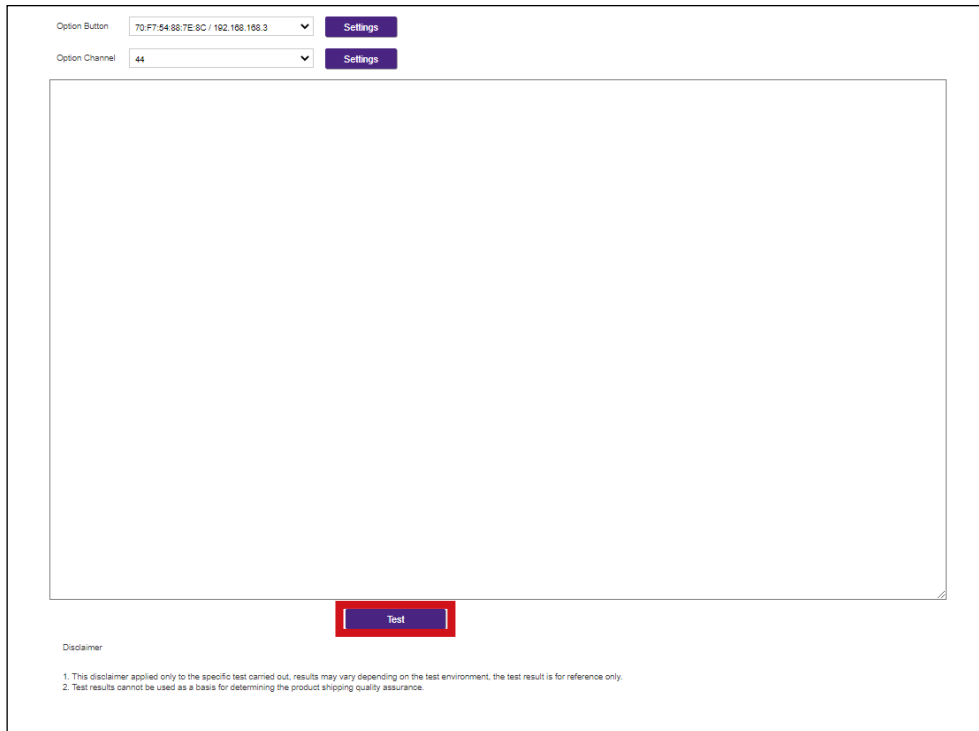

Log Setting

Logs are records of all system activity for your Host, which may be used by support technicians to track errors or locate bugs. In the **Log Setting** menu you can:

- Download the system log to your local computer by clicking **Download To PC**
- Clear the system log by clicking **Clear Log**.
- View the system log in the **System Log View** window.

The screenshot displays the BenQ router's web interface. On the left, a vertical sidebar contains various settings categories. The 'Log Setting' option is highlighted with a red rectangular border. The main content area is divided into three sections:

- Download to PC:** Contains two buttons: 'Download to PC' and 'Download TX Log'.
- Clear Log:** Contains one button: 'Clear Log'.
- System Log View:** A scrollable text area displaying system logs. The logs include timestamps and messages such as 'Network device 'lo' link is up', 'interface 'loopback' has link connectivity', 'DHCP IP range 192.168.100.110 -- 192.168.100.126, lease time 6h', and 'admin is login successful'.

Legal Announcement

For information about disclaimer or privacy policy, press **Legal Announcement** to find out more.

Troubleshooting

Category	Problem	Cause	Solution
Your screen	Your screen is not appearing on the display when pressing the Button.	The Button is connecting to another Host.	The Button should be paired again with the Host.
		Pressing time is not enough.	Press the Present key until the LED indicator turns from green to blue.
	The screen turns blank or flickers when the Host is presenting.	Insufficient power supply.	Make sure the product's power is properly supplied or connected.
	The screen lags seriously and the audio breaks up sometimes.	Insufficient power supply for the Button. An laptop with USB 2.0 port may be used as the power supply for the Button.	Make sure you use USB 3.0 as the power supply for the Button.
		Wi-Fi interference or signal attenuation	<ul style="list-style-type: none"> • Make sure the transmission distance is within 15 meters and with no obstacles. • Restart the Host in order to rescan the Wi-Fi 5G channel. • Log in Web Management > Wireless Network > Wi-Fi Radio Setup > toggle the Transmission power
The Button	The Button automatically restarts sometimes.	Insufficient power supply.	Make sure you use USB 3.0 as the power supply for the Button.
	The LED indicator on the Button remains static red even after it has been powered on for 30 seconds.	The Button has not been properly powered off during the resetting process.	Reset the Button.
	The pairing function Reset the Button. Cannot be executed via the MODE key while the Button is powered on and the LED starts flashing red.		
The Host	Nothing is shown on the display at all.	The display is switched off.	Switch on the display.
		The wrong input is selected.	Select the correct input.

Category	Problem	Cause	Solution
The Host	Nothing is shown on the display at all.	The video cable is not connected properly.	Insert the HDMI cable between the Host and the display device again.
		The display fails to show the Host's output resolution at 1080p in "Guide Screen" or "Idle Screen".	Replace the display with a new one that supports output resolution at 1080p.
		The Host is in Network Standby Mode when Video Conference Standby Mode and the function in enabled.	Press the Present key of the Button to start presentation.
		The Host is powered off.	Briefly press the standby button on the Host.
	Insufficient power supply.	Change power supply of Host to a power adapter.	
	The LED indicator on the Host remains static red even after it has been powered on for 30 seconds.	The Host has not been properly powered off during the resetting process.	Reset the Host.
EDID	After connecting the Button to your laptop, the second screen (InstaShow™) cannot be detected.	The HDMI connection between your laptop and the Button is loose.	Reconnect the HDMI cable of the Button.
		Laptop problem	Reboot your laptop.
		The Button is shutdown.	Reconnect the USB cable of the Button.
Pairing	The message, Pairing failed , from the Host is shown on the display when the Host is pairing with the Button.	1. Error: 1103 2. The Host has reached the maximum number of pairing.	Log into the web management, then select Pairing > Pairing Status > Delete Delete unnecessary pairings.
		Wi-Fi interference or signal attenuation	Make sure the transmission distance is within 15 meters and with no obstacles.
		The Button has not entered the pairing mode in time.	When the Host enters pairing mode, the Button should also enter pairing mode within two minutes.

Category	Problem	Cause	Solution
Windows Software	When presenting a video file via GOM Media Player, the full-screen image is cut into upper and lower halves.	Media player	Use other media players to play video files, such as Windows Media Player.
Web management	Cannot Log in	Forget the account and password.	1. Reset the Host. 2. The default log in account: admin 3. The default log in password: 0000.
	Laptop cannot connect the SSID with the correct password by Wi-Fi.	Laptop Wi-Fi module cannot support 802.11 AC.	Laptop can connect to the Host with an Ethernet cable instead of Wi-Fi connection.

Error code

RX Error Code	Cause
0101	Firmware file error
1101	Pairing Time Expired
1102	Manually stop pairing
1103	Pairing limit reached
2101	The fan has stopped working



BenQ.com

© 2023 BenQ Corporation.
All rights reserved. Rights of modification reserved.