

# OmniStream™ Wallplate Networked AV Encoder



## Version Information

---

Version	Release Date	Notes
1	Sep 2019	Initial release

## Welcome to Atlona!

---

Thank you for purchasing this Atlona product. We hope you enjoy it and will take a extra few moments to register your new purchase.

Registration only takes a few minutes and protects this product against theft or loss. In addition, you will receive notifications of product updates and firmware. Atlona product registration is voluntary and failure to register will not affect the product warranty.

To register your product, go to <http://www.atlona.com/registration>

## Sales, Marketing, and Customer Support

---

### Main Office

Atlona Incorporated  
70 Daggett Drive  
San Jose, CA 95134  
United States

Office: +1.877.536.3976 (US Toll-free)  
Office: +1.408.962.0515 (US/International)

Sales and Customer Service Hours  
Monday - Friday: 6:00 a.m. - 4:30 p.m. (PST)

<http://www.atlona.com/>

### International Headquarters

Atlona International AG  
Ringstrasse 15a  
8600 Dübendorf  
Switzerland

Office: +41 43 508 4321

Sales and Customer Service Hours  
Monday - Friday: 09:00 - 17:00 (UTC +1)

## Operating Notes

---

- The Atlona Management System (AMS) is a free downloadable application from Atlona that provides network configuration assistance for this product. This application is available only for the Windows® Operating System and can be downloaded from the Atlona web site.



**IMPORTANT:** Visit <http://www.atlona.com/product/AT-OMNI-111-WP> for the latest firmware updates and User Manual.



**NOTE:** Scaling and deinterlacing is not supported at 1080i.

# Atlona, Inc. (“Atlona”) Limited Product Warranty

---

## Coverage

Atlona warrants its products will substantially perform to their published specifications and will be free from defects in materials and workmanship under normal use, conditions and service.

Under its Limited Product Warranty, Atlona, at its sole discretion, will either:

- repair or facilitate the repair of defective products within a reasonable period of time, restore products to their proper operating condition and return defective products free of any charge for necessary parts, labor and shipping.

OR

- replace and return, free of charge, any defective products with direct replacement or with similar products deemed by Atlona to perform substantially the same function as the original products.

OR

- refund the pro-rated value based on the remaining term of the warranty period, not to exceed MSRP, in cases where products are beyond repair and/or no direct or substantially similar replacement products exist.

Repair, replacement or refund of Atlona products is the purchaser’s exclusive remedy and Atlona liability does not extend to any other damages, incidental, consequential or otherwise.

This Limited Product Warranty extends to the original end-user purchaser of Atlona products and is non-transferrable to any subsequent purchaser(s) or owner(s) of these products.

## Coverage Periods

Atlona Limited Product Warranty Period begins on the date of purchase by the end-purchaser. The date contained on the end-purchaser’s sales or delivery receipt is the proof purchase date.

### Limited Product Warranty Terms – New Products

- 10 years from proof of purchase date for hardware/electronics products purchased on or after June 1, 2013.
- 3 years from proof of purchase date for hardware/electronics products purchased before June 1, 2013.
- Lifetime Limited Product Warranty for all cable products.

### Limited Product Warranty Terms – Refurbished (B-Stock) Products

- 3 years from proof of purchase date for all Refurbished (B-Stock) hardware and electronic products purchased on or after June 1, 2013.

## Remedy

Atlona recommends that end-purchasers contact their authorized Atlona dealer or reseller from whom they purchased their products. Atlona can also be contacted directly. Visit [www.atlona.com](http://www.atlona.com) for Atlona’s contact information and hours of operation. Atlona requires that a dated sales or delivery receipt from an authorized dealer, reseller or end-purchaser is provided before Atlona extends its warranty services. Additionally, a return merchandise authorization (RMA) and/or case number, is required to be obtained from Atlona in advance of returns.

Atlona requires that products returned are properly packed, preferably in the original carton, for shipping. Cartons not bearing a return authorization or case number will be refused. Atlona, at its sole discretion, reserves the right to reject any products received without advanced authorization. Authorizations can be requested by calling 1-877-536-3976 (US toll free) or 1-408- 962-0515 (US/international) or via Atlona’s website at [www.atlona.com](http://www.atlona.com).

## Exclusions

This Limited Product Warranty excludes:

- Damage, deterioration or malfunction caused by any alteration, modification, improper use, neglect, improper packaging or shipping (such claims must be presented to the carrier), lightning, power surges, or other acts of nature.

## Atlona, Inc. (“Atlona”) Limited Product Warranty

---

- Damage, deterioration or malfunction resulting from the installation or removal of this product from any installation, any unauthorized tampering with this product, any repairs attempted by anyone unauthorized by Atlona to make such repairs, or any other cause which does not relate directly to a defect in materials and/or workmanship of this product.
- Equipment enclosures, cables, power supplies, batteries, LCD displays, and any accessories used in conjunction with the product(s).
- Products purchased from unauthorized distributors, dealers, resellers, auction websites and similar unauthorized channels of distribution.

### Disclaimers

This Limited Product Warranty does not imply that the electronic components contained within Atlona’s products will not become obsolete nor does it imply Atlona products or their electronic components will remain compatible with any other current product, technology or any future products or technologies in which Atlona’s products may be used in conjunction with. Atlona, at its sole discretion, reserves the right not to extend its warranty offering in instances arising outside its normal course of business including, but not limited to, damage inflicted to its products from acts of god.

### Limitation on Liability

The maximum liability of Atlona under this limited product warranty shall not exceed the original Atlona MSRP for its products. To the maximum extent permitted by law, Atlona is not responsible for the direct, special, incidental or consequential damages resulting from any breach of warranty or condition, or under any other legal theory. Some countries, districts or states do not allow the exclusion or limitation of relief, special, incidental, consequential or indirect damages, or the limitation of liability to specified amounts, so the above limitations or exclusions may not apply to you.

### Exclusive Remedy

To the maximum extent permitted by law, this limited product warranty and the remedies set forth above are exclusive and in lieu of all other warranties, remedies and conditions, whether oral or written, express or implied. To the maximum extent permitted by law, Atlona specifically disclaims all implied warranties, including, without limitation, warranties of merchantability and fitness for a particular purpose. If Atlona cannot lawfully disclaim or exclude implied warranties under applicable law, then all implied warranties covering its products including warranties of merchantability and fitness for a particular purpose, shall provide to its products under applicable law. If any product to which this limited warranty applies is a “Consumer Product” under the Magnuson-Moss Warranty Act (15 U.S.C.A. §2301, ET SEQ.) or other applicable law, the foregoing disclaimer of implied warranties shall not apply, and all implied warranties on its products, including warranties of merchantability and fitness for the particular purpose, shall apply as provided under applicable law.

### Other Conditions

Atlona’s Limited Product Warranty offering gives legal rights, and other rights may apply and vary from country to country or state to state. This limited warranty is void if (i) the label bearing the serial number of products have been removed or defaced, (ii) products are not purchased from an authorized Atlona dealer or reseller. A comprehensive list of Atlona’s authorized distributors, dealers and resellers can be found at [www.atlona.com](http://www.atlona.com).

## Important Safety Information



CAUTION: TO REDUCE THE RISK OF ELECTRIC SHOCK DO NOT OPEN ENCLOSURE OR EXPOSE TO RAIN OR MOISTURE. NO USER-SERVICEABLE PARTS INSIDE REFER SERVICING TO QUALIFIED SERVICE PERSONNEL.



The exclamation point within an equilateral triangle is intended to alert the user to the presence of important operating and maintenance instructions in the literature accompanying the product.



The information bubble is intended to alert the user to helpful or optional operational instructions in the literature accompanying the product.

1. Read these instructions.
2. Keep these instructions.
3. Heed all warnings.
4. Follow all instructions.
5. Do not use this product near water.
6. Clean only with a dry cloth.
7. Do not block any ventilation openings. Install in accordance with the manufacturer's instructions.
8. Do not install or place this product near any heat sources such as radiators, heat registers, stoves, or other apparatus (including amplifiers) that produce heat.
9. Do not defeat the safety purpose of a polarized or grounding-type plug. A polarized plug has two blades with one wider than the other. A grounding type plug has two blades and a third grounding prong. The wide blade or the third prong are provided for your safety. If the provided plug does not fit into your outlet, consult an electrician for replacement of the obsolete outlet.
10. Protect the power cord from being walked on or pinched particularly at plugs, convenience receptacles, and the point where they exit from the product.
11. Only use attachments/accessories specified by Atlona.
12. To reduce the risk of electric shock and/or damage to this product, never handle or touch this unit or power cord if your hands are wet or damp. Do not expose this product to rain or moisture.
13. Unplug this product during lightning storms or when unused for long periods of time.
14. Refer all servicing to qualified service personnel. Servicing is required when the product has been damaged in any way, such as power-supply cord or plug is damaged, liquid has been spilled or objects have fallen into the product, the product has been exposed to rain or moisture, does not operate normally, or has been dropped.



## FCC Statement

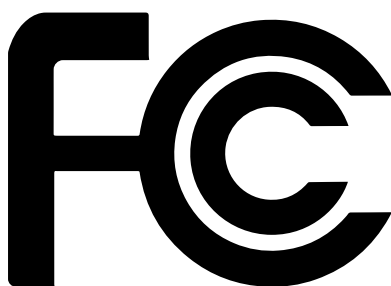

FCC Compliance and Advisory Statement: This hardware device complies with Part 15 of the FCC rules. Operation is subject to the following two conditions: 1) this device may not cause harmful interference, and 2) this device must accept any interference received including interference that may cause undesired operation. This equipment has been tested and found to comply with the limits for a Class A digital device, pursuant to Part 15 of the FCC Rules. These limits are designed to provide reasonable protection against harmful interference in a commercial installation.

This equipment generates, uses, and can radiate radio frequency energy and, if not installed or used in accordance with the instructions, may cause harmful interference to radio communications. However there is no guarantee that interference will not occur in a particular installation. If this equipment does cause harmful interference to radio or television reception, which can be determined by turning the equipment off and on, the user is encouraged to try to correct the interference by one or more of the following measures: 1) reorient or relocate the receiving antenna; 2) increase the separation between the equipment and the receiver; 3) connect the equipment to an outlet on a circuit different from that to which the receiver is connected; 4) consult the dealer or an experienced radio/TV technician for help. Any changes or modifications not expressly approved by the party responsible for compliance could void the user's authority to operate the equipment. Where shielded interface cables have been provided with the product or specified additional components or accessories elsewhere defined to be used with the installation of the product, they must be used in order to ensure compliance with FCC regulations.

# Table of Contents

---

<b>Introduction</b>	<b>8</b>
<b>Features</b>	<b>8</b>
<b>Package Contents</b>	<b>8</b>
<b>Panel Description</b>	<b>9</b>
Connection Instructions	10
Connection Diagram	11
<b>Configuration</b>	<b>12</b>
Accessing Encoders in AMS	12
Configuring a Static IP Address	16
Input Selection	17
Input Selection	17
Verifying the Input	18
Session Configuration	19
<b>Basic Operation</b>	<b>20</b>
LED Indicators	20
Rebooting OmniStream	21
Unicast Mode	22
Multicast Mode	24
802.1X Authentication	26
AES67 Audio	29
EDID Management	30
Selecting an EDID Preset	30
Using a Custom EDID	30
Copying an EDID from the Display	32
Encoder Grouping	35
Scrambling	37
Standard Method	37
Using the Virtual Matrix	38
Setting the Video Mode	39
Slate / Logo Insertion	40
Adding Slates / Logos	40
Deleting Slates / Logos	43
Text Insertion	44
<b>The AMS Interface</b>	<b>45</b>
Device Info page	45
Input page	47
Serial page	50
Session page	51
Network page	54
Other page	56
Logo	56
Text	57
PTP	58
The Virtual Matrix	60
Layout and Operation	61
<b>Appendix</b>	<b>63</b>
Updating the Firmware	63
FEC Details	65
Matrix Size, Overhead, and Latency	65
FEC and Video Bitrate	65
FEC, Latency, and Lip Sync	66
Specifications	67

## Introduction

---

The Atlona **OmniStream™ 111 Wallplate (AT-OMNI-111-WP)** is a single-channel networked AV encoder for HDMI 2.0 sources up to 4K @ 60 Hz and HDR (High Dynamic Range), plus embedded audio. It features a US two-gang, Decora-style wallplate form factor, and includes interchangeable black and white wallplates and faceplates. The OmniStream 111 WP is part of the OmniStream Pro Series, designed for high performance, flexible distribution of AV over standard, off-the-shelf Gigabit Ethernet switches in commercial audiovisual applications. It is HDCP 2.2 compliant and ideal for the latest Ultra High-Definition and HDR sources. This networked AV encoder features advanced high-quality, VC-2 visually lossless video compression technology with user-selectable, video quality optimization engines designed for computer-generated imaging, or motion video content. The Atlona OmniStream 111 WP achieves extremely low, sub-frame latency when paired with OmniStream AV decoders.

With its wallplate form factor, the OmniStream 111 WP enables convenient installation wherever an aesthetically appealing or discreet AV source connection is required.

## Features

---

- Best-in-class AV over IP performance and reliability over Gigabit Ethernet.
- US two-gang enclosure for Decora-style wallplate openings – interchangeable black or white trim kits.
- AV encoder for HDMI up to 4K/UHD, plus embedded audio.
- Networked AV redundancy.
- Supports UHD @ 60 Hz plus HDR formats.
- High performance, visually lossless video compression.
- HDCP compliance.
- Network error resilience with FEC (forward error correction).
- Simplify integration with plug-and-play network switch compatibility.
- Remote PoE (Power over Ethernet) powering.
- Secure content distribution with AES-128 encryption.
- Supports industry-standard, network security features and protocols.
- AES67-compatible audio over IP streaming.
- Simultaneous OmniStream and AES67 audio streaming.
- Enhance AV presentations with visual enhancements.
- EDID management.
- Encoder grouping.
- Audio processing and pass-through.
- System management.
- Award-winning 10 year limited product warranty.

## Package Contents

---

- 1 x AT-OMNI-111-WP
- 1 x Black faceplate
- 1 x White Decora® wallplate
- 1 x Black Decora® wallplate
- 1 x 3.5 mm-to-DE-9 (M-F) cable
- 4 x Spare screws
- 1 x Installation Guide



# Panel Description

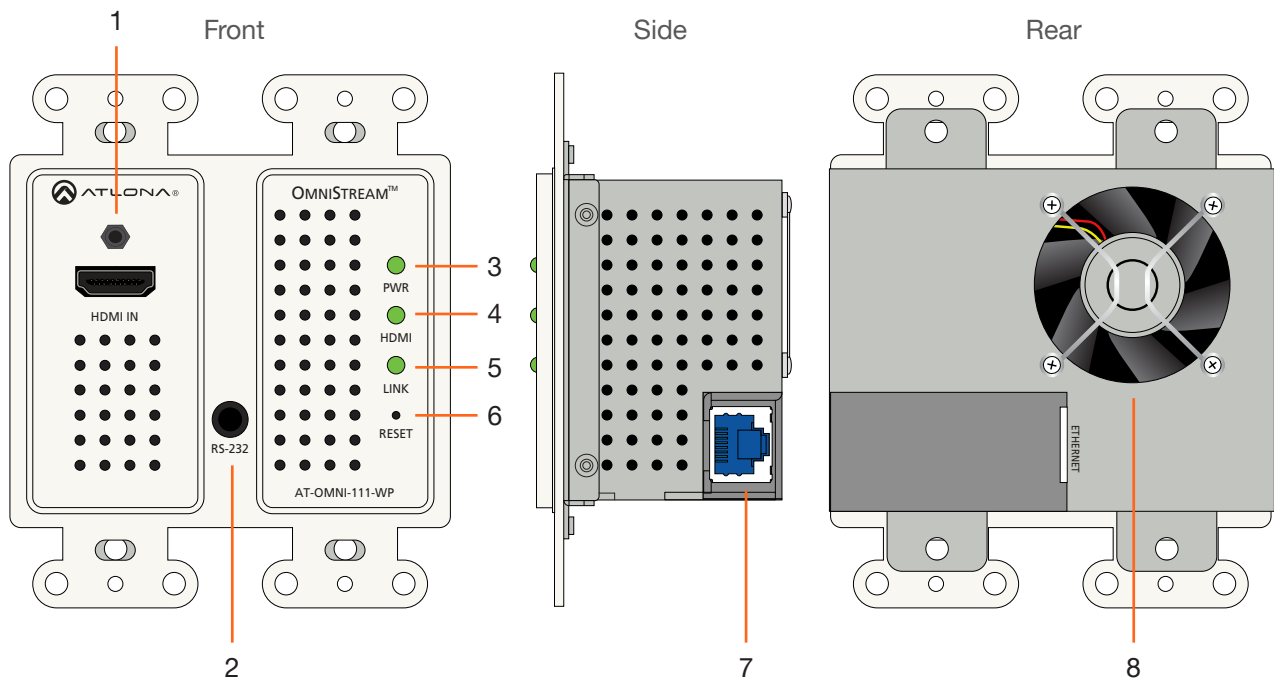

## 1 HDMI IN

Connect an HDMI cable from this port to an HD source.

## 2 RS-232

This is a service port used for future management purposes.

## 3 PWR

This LED indicator glows bright green when the unit is powered.

## 4 HDMI

This LED indicator shows the input status.

## 5 LINK

This LED indicator is green when the link integrity between the AT-OMNI-111-WP and the switch is good.

## 6 RESET

Press and release this button to reboot the AT-OMNI-111-WP. Note that this operation *does not* reset the unit to factory-default settings.

## 7 ETHERNET

Connect an Ethernet cable from this port to the Local Area Network (LAN).

## 8 Fan

This fan provides internal cooling by forcing hot air from the wallplate chassis. Make sure adequate ventilation is provided when installing the AT-OMNI-111-WP.

## Connection Instructions



**IMPORTANT:** The venting holes, surrounding the enclosure, along with the fan assembly on the back of the unit, provides cooling by expelling warm air from the enclosure. To prevent overheating, make sure these holes and the fan assembly are not blocked.

1. Connect an Ethernet cable from the **ETHERNET** port on the AT-OMNI-111-WP to a PoE-capable switch on the Local Area Network (LAN).
2. Install the AT-OMNI-111-WP into a 2-gang electrical box or mud ring.
3. Attach the included Decora® wallplate to secure the AT-OMNI-111-WP to the wall/surface.
4. Connect an HDMI cable from a HD/UHD source to the **HDMI IN** port on the AT-OMNI-111-WP.
5. The **PWR** indicator, on the front panel, displays the power status. When the AT-OMNI-111-WP is powered, the **PWR** LED initially turns red. After a few moments it will turn amber, and finally green.
6. The AT-OMNI-111-WP is now ready for operation.

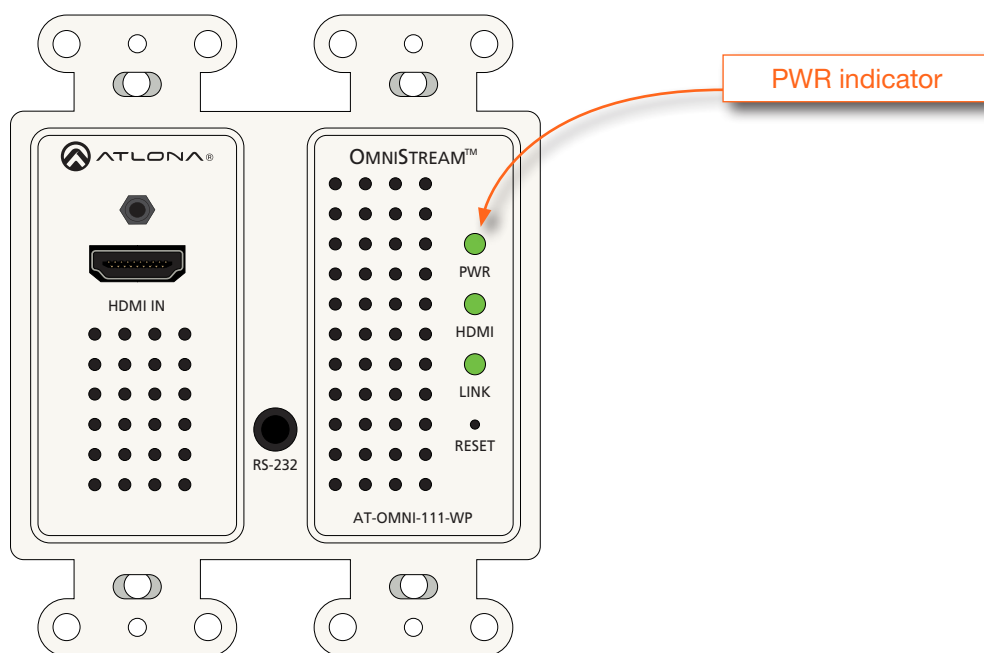

### Connection Diagram

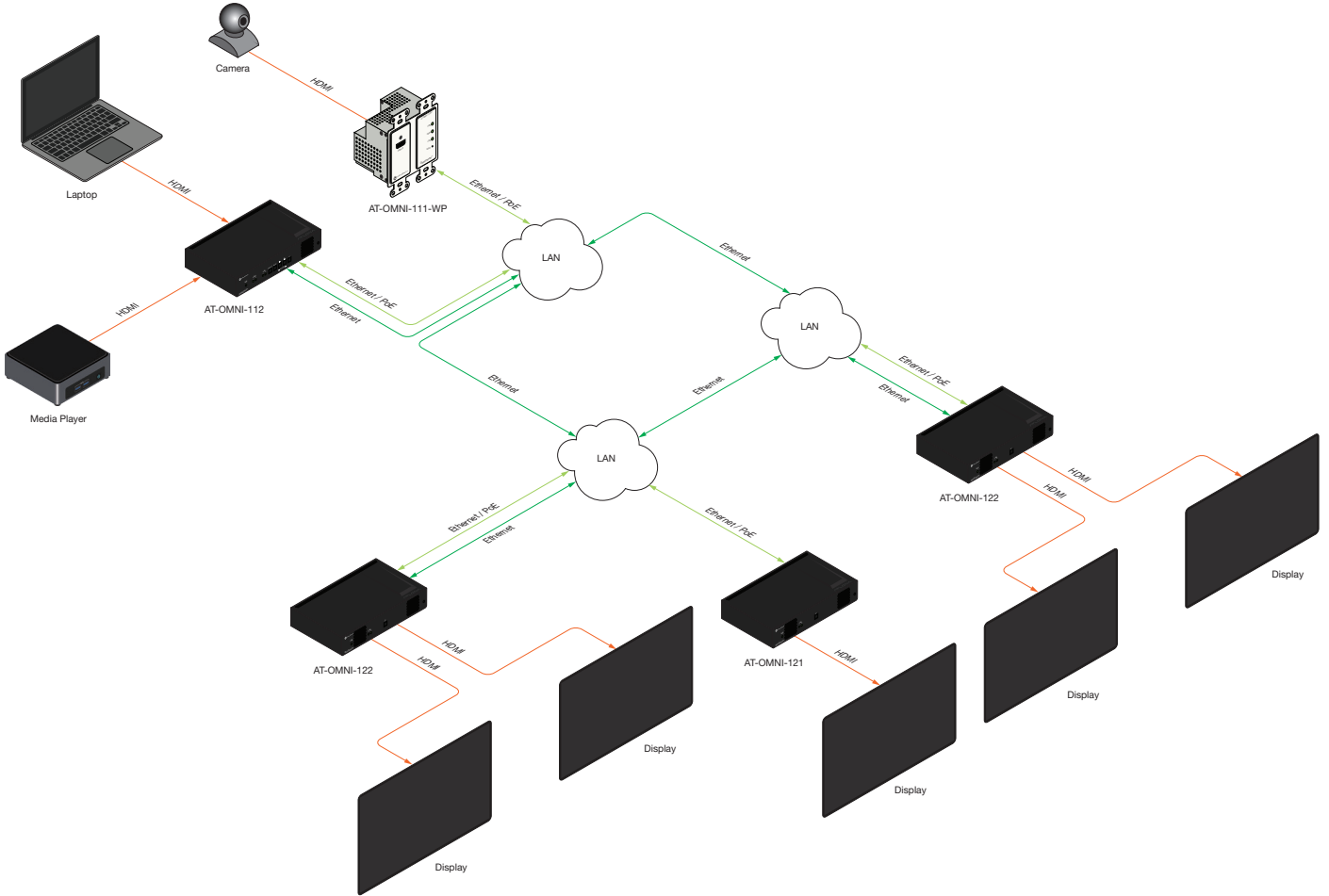

# Configuration

## Accessing Encoders in AMS

It is recommended that the Atlona Management System (AMS) be used to configure and control OmniStream devices. AMS uses multicast Domain Name Server (mDNS) to automatically discover each encoder on the network. AMS is free and can be downloaded from <https://www.atlona.com/ams>.

By default, encoders are set to DHCP mode, allowing a DHCP server (if present) to assign the encoder an IP address. Once an IP address has been assigned, the Atlona Management System (AMS) can be used to manage the product on the network. Note that AMS will only be able to discover encoders if they are on the same VLAN.

In order for AMS to automatically assign multicast IP addresses to OmniStream encoders, the destination IP addresses for the session streams must be cleared.

**NOTE:** The following steps are required *only if a pre-existing multicast IP address* is assigned to each session and if automatic assignment of these multicast IP addresses, using AMS, is desired.

1. Launch a web browser and enter the IP address of AMS, in the address bar.
2. Enter the required login credentials. The default login is:

Username: admin  
 Password: Atlona

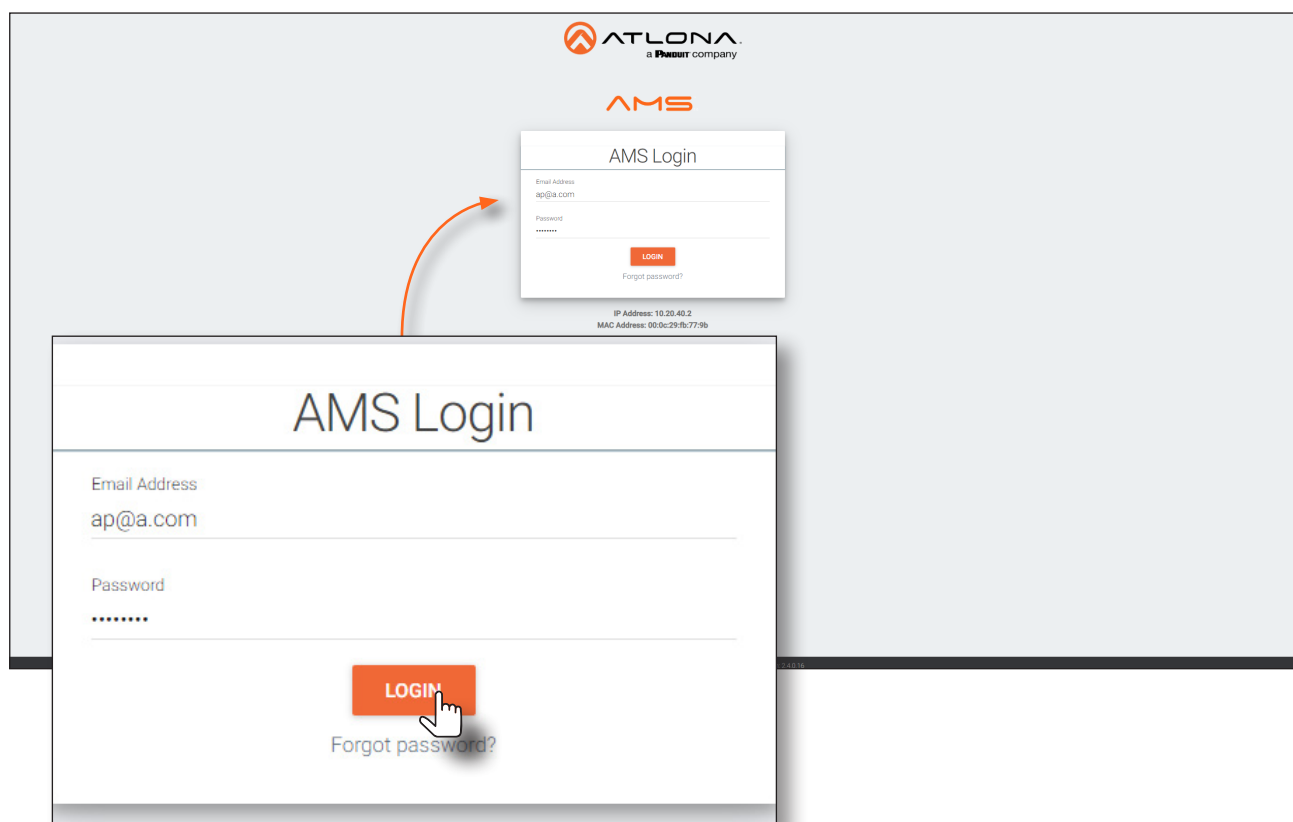

3. Click the **Login** button.
4. The AMS Dashboard will be displayed.
5. Click the ☰ icon, in the upper-left corner of the AMS Dashboard.

6. Click **Devices** from the fly-out menu.

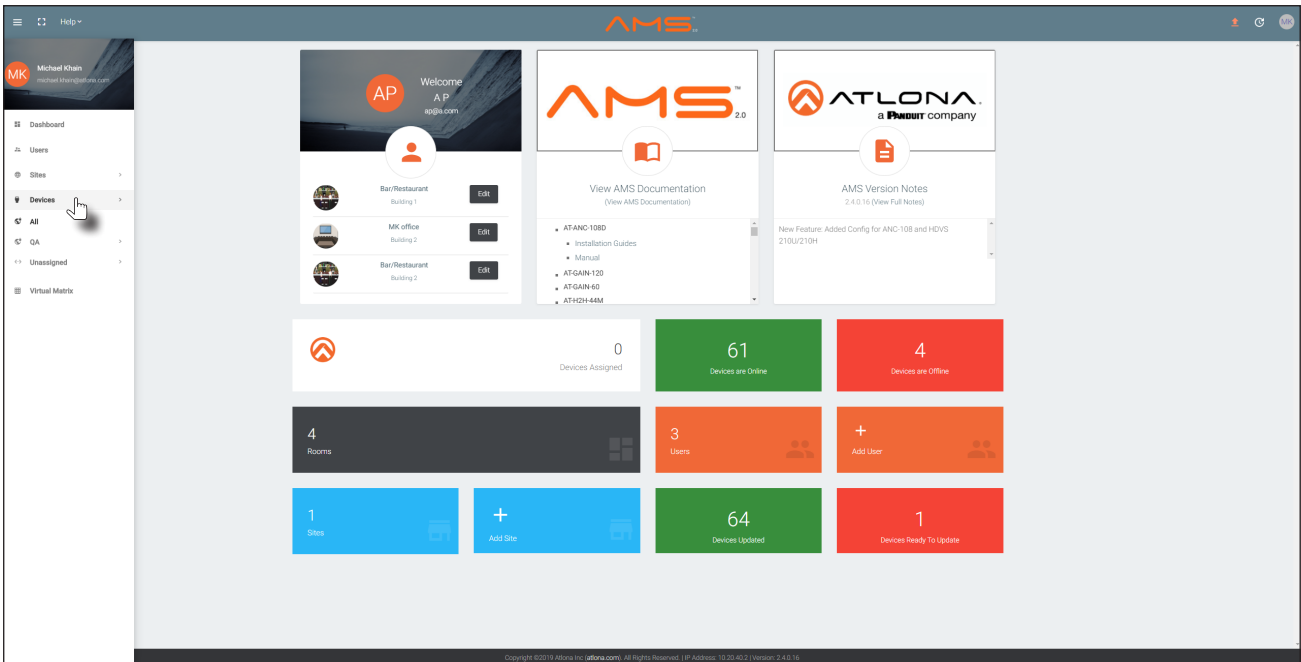

7. Click the **Unassigned** option.

8. If the device isn't immediately listed, click the left and right arrows, at the bottom of the **Unassigned** list, to scroll through all available devices.

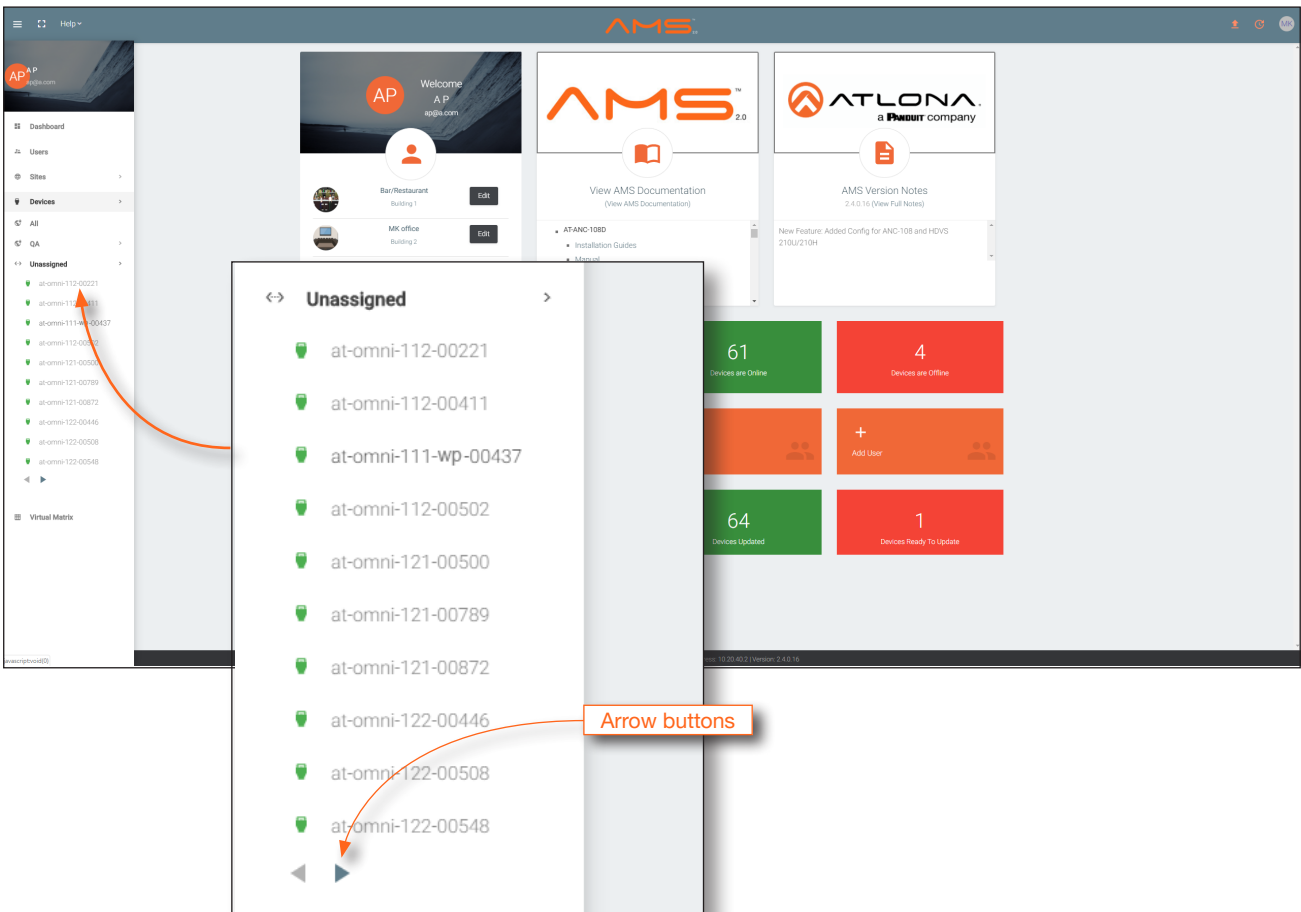

All available encoders will be displayed under the **Unassigned** category. When an encoder is unassigned, it means that it has not been assigned to a site, building, and/or room. Refer to the AMS User Manual for more information on these topics.

If a DHCP server is not found within 60 seconds, the encoder will be placed in Auto IP mode and assigned an IP address within the range of 169.254.xxx.xxx. If this occurs, configure the network interface of the computer that is running AMS, located on the same subnet (169.254.xxx.xxx, subnet mask 255.255.0.0). Refer to [Configuring a Static IP Address \(page 16\)](#) for more information on configuring an encoder in Auto IP mode.

If no OmniStream encoders are found, then verify the following:

- The computer that is running AMS must be on the same network as the OmniStream device.
- Remove any network restrictions that may be in place. In order for mDNS to function properly, there must not be restrictions applied to the network.

9. Click the desired encoder within the **Unassigned** list.

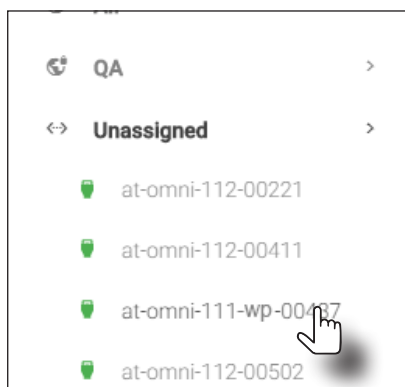

10. Once the unit is selected, the control interface for the encoder will be displayed.

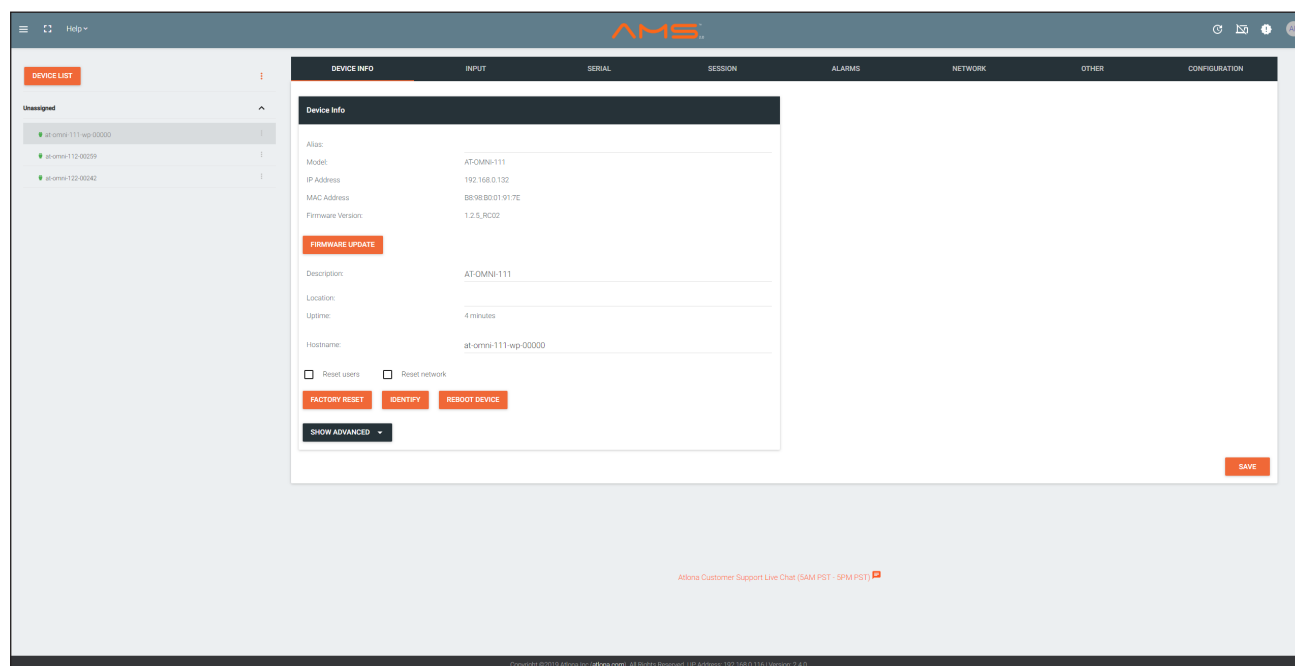

11. Click **SESSION** in the top menu bar.

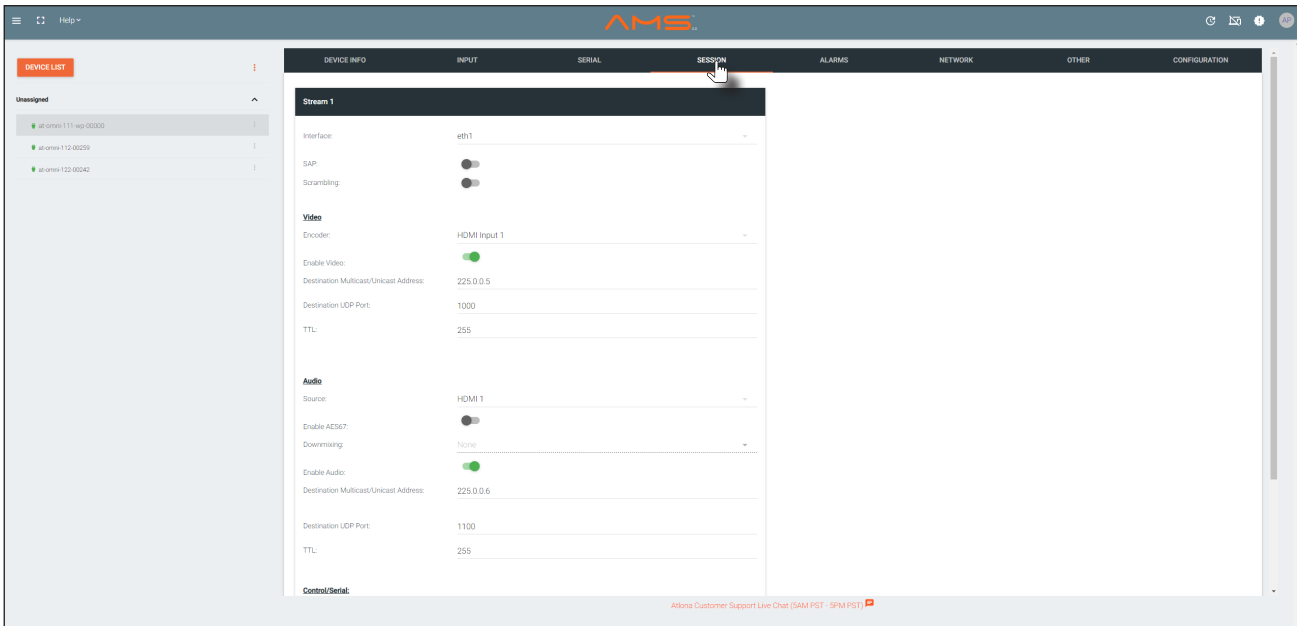

12. Locate the **Video** section.

13. Delete the value in the **Destination Multicast / Unicast Address** field.

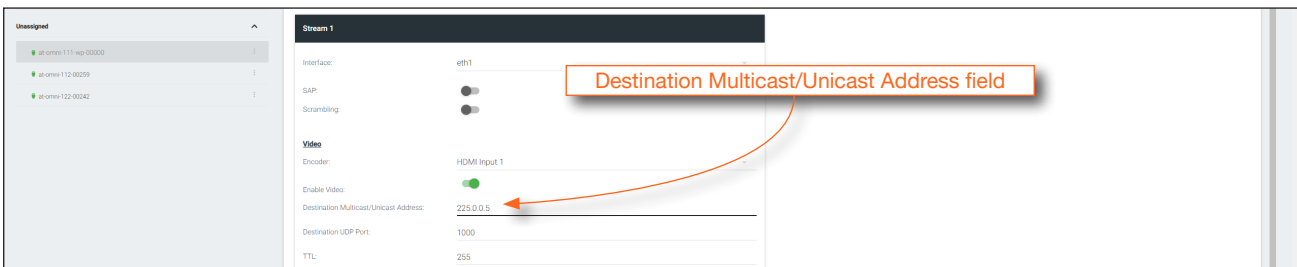

14. Locate the **Audio** section and delete the value in the **Destination Multicast / Unicast Address** field.

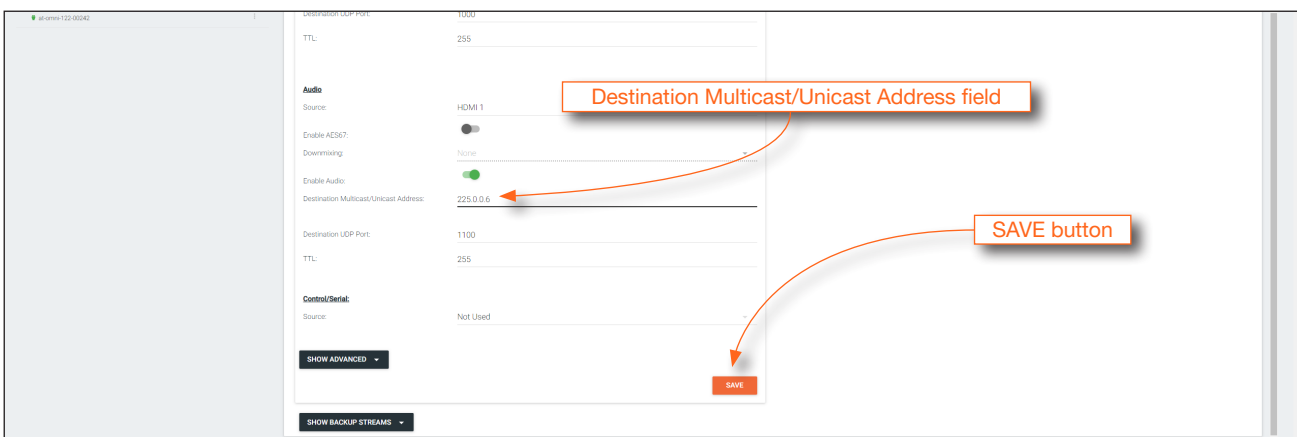

15. Scroll down to the bottom of the page and click the **SAVE** button at the bottom of the **Stream 1** window group.

## Configuring a Static IP Address

The following section is only required to when setting an encoder to a static IP address. If a DHCP server is not found within 60 seconds, encoders are automatically placed in Auto IP mode and will be assigned an IP address within the range 169.254.xxx.xxx. If this occurs, a static IP address can be assigned to the encoder in order for AMS to locate it on the network.

1. Make sure that the encoder is powered. The AT-OMNI-111-WP is powered by connecting an Ethernet cable from the encoder to a PoE-capable switch.
2. Connect an Ethernet cable from the PC, directly to the Ethernet port on the rear of the encoder. Make sure that the computer being used has AMS installed.
3. Configure the PC to a static IP address that is on the same subnet as the encoder.



**IMPORTANT:** Windows: Before continuing, write down the current IP settings in order to restore them, later. If *Obtain an IP address automatically* and *Obtain DNS server automatically* are selected, then this step is not required.

4. Login to AMS. Refer to [Accessing Encoders in AMS \(page 12\)](#) for information on the login process.
5. Locate the encoder under the **Unassigned** section within AMS.
6. Click on the device.
7. Under AMS, click **NETWORK** in the menu bar.

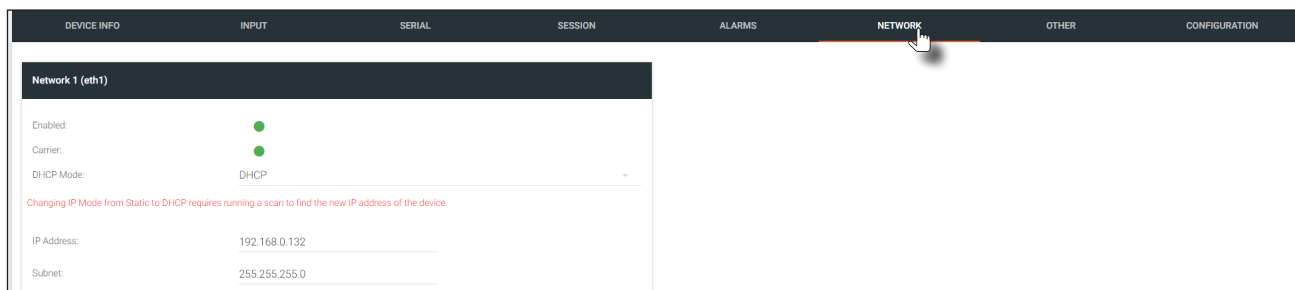

8. Click the **DHCP Mode** drop-down list and select **Static**.

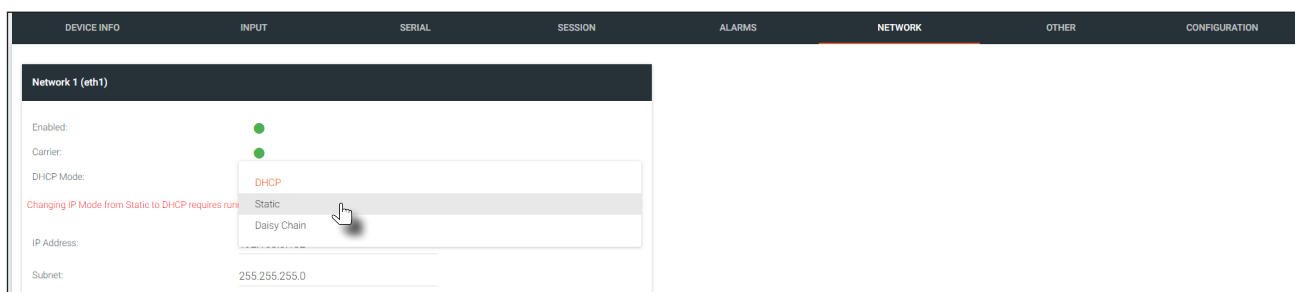

9. Enter the required network information for the encoder in the **IP Address**, **Subnet**, and **Gateway** fields.
10. Click the **Save** button in the bottom-right corner, to apply the changes.
11. Disconnect the encoder from the PC and connect the encoder to the network.
12. The encoder is now ready for use.



## Input Selection

Once the OmniStream encoder is configured, and can be located on the network, the encoder will need to be instructed on how to handle source devices and to which stream each source is assigned.

### Input Selection

1. Under AMS, click **INPUT** in the menu bar.
2. Click the **Input** drop-down list for **HDMI Input 1** and select the input.

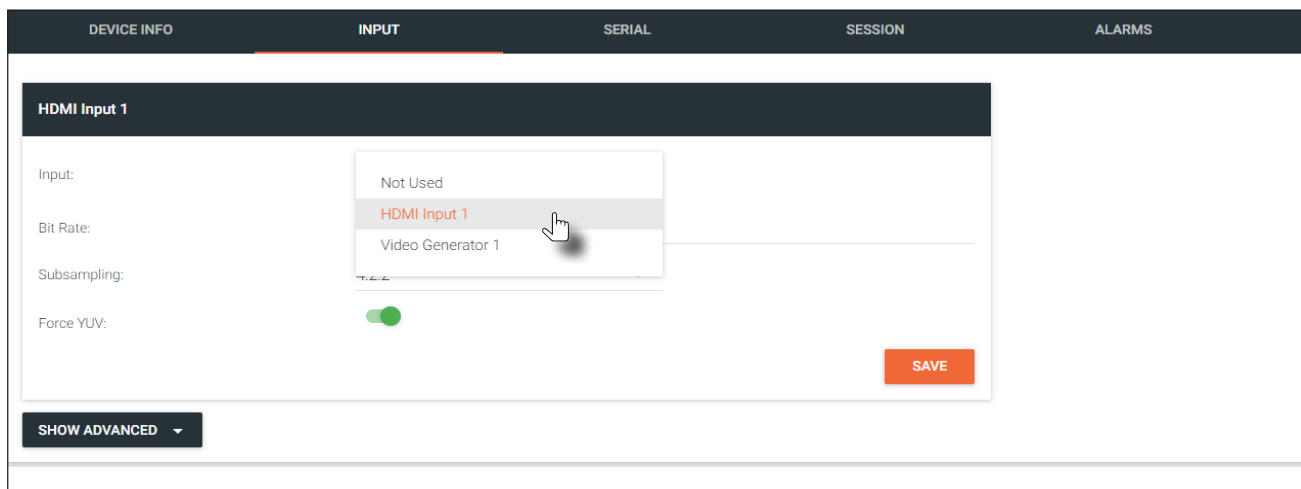

3. Enter the desired bit rate in the **Bit Rate** field. Specifying lower bit rates will reduce video quality. This value is in megabits-per-second (Mbps). 4K/UHD streams should be set to 900 Mbps. The recommended bandwidth for 1080p60 video is also 450 Mbps. Setting this field below these recommended values will result in lower-quality video.
4. Enter the bit depth from the **Bit Depth** drop-down list.
5. Select the chroma subsampling value from the **Subsampling** drop-down list. Available values are 4:2:0, 4:2:2, and 4:4:4.
6. Click the **Force YUV** toggle switch to enable or disable the use of YUV color space. Enable (the toggle switch will be green) this feature to force the output of the encoder to output YUV, regardless of whether the input is RGB or YUV. In order for the chroma scaling to work on RGB inputs, this feature must be enabled.

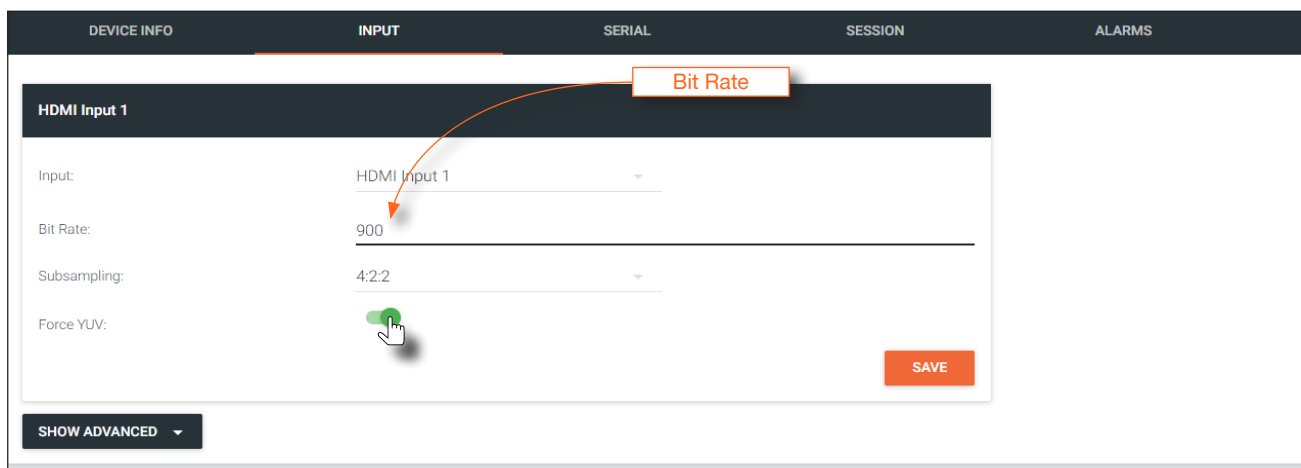

7. Click the **SAVE** button in the right-hand corner of the **HDMI Input 1** window group to commit changes.

## Verifying the Input

1. Click **INPUT** in the menu bar.

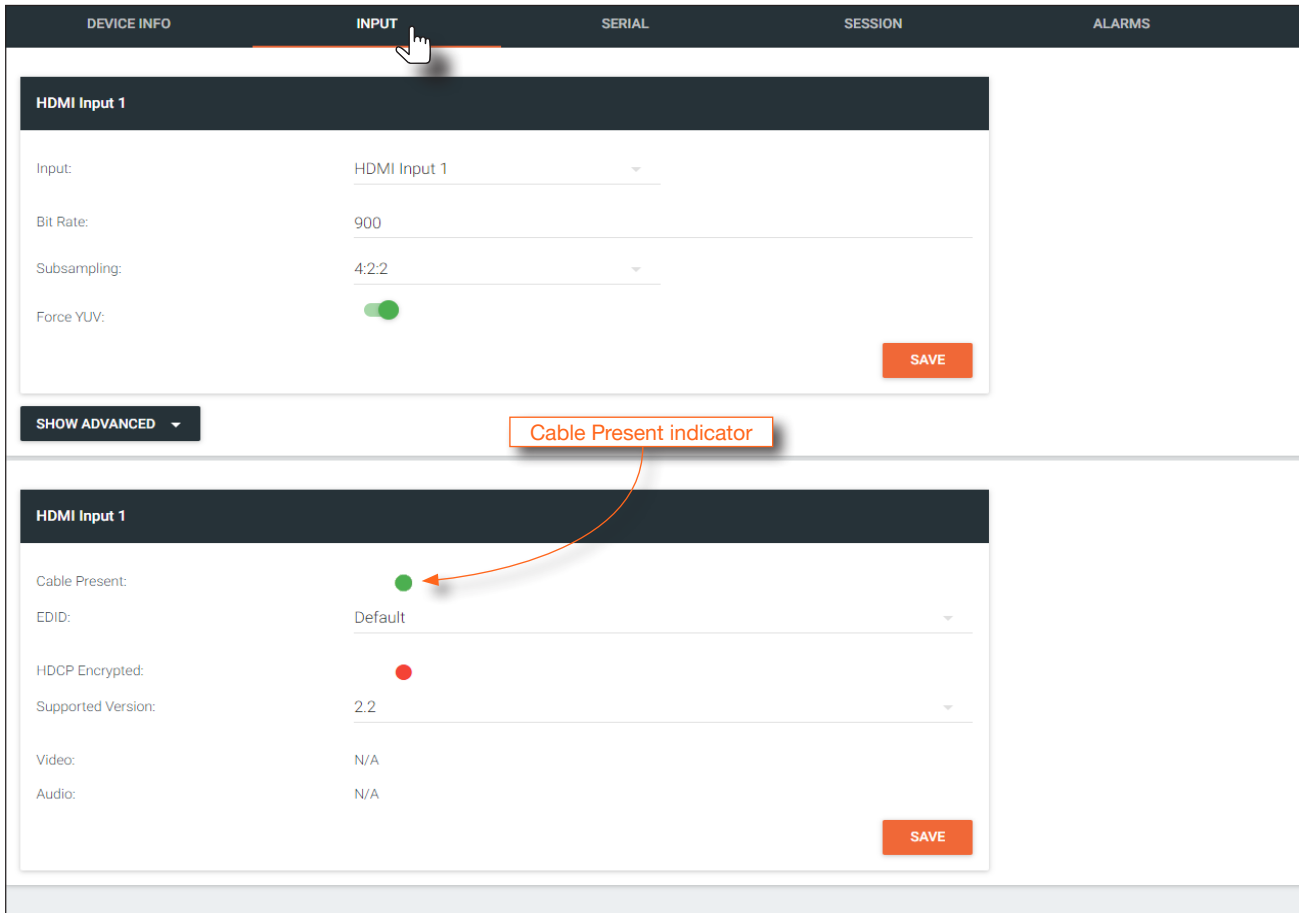

2. Check the **Cable Present** indicator. If a cable is connected from a source to an input on the encoder, then the indicator will be green. If no cable is connected, then the indicator will be red.

Note that this indicator may also reflect the integrity of the cable: if the cable is bad or does not maintain a secure connection, then the **Cable Present** indicator may also be displayed as red. If this is the case, try a different HDMI cable.

## Session Configuration

Once the inputs have been assigned to the desired source, the next step is to configure each *session*. A *session* is a class-D multicast IP address that is assigned to an AV stream. If each stream is configured for bit rates less than 450 Mbps (only recommended for 1080p and lower resolutions), a single Ethernet cable can transport two sessions. The single-channel encoder supports a maximum of two sessions to enable redundancy for single 1080p-use cases.

### Video

1. Under AMS, click **Session** in the menu bar.
2. Click the **eth1** physical interface from the **Interface** drop-down list.
3. Select the **HDMI Input 1** from the **Encoder** drop-down list.
4. Under the **Video** section, make sure that the **Enable Video** toggle switch is enabled (green). To disable video at any time, click the toggle switch so that it appears gray.
5. Enter the destination multicast IP address in the **Destination Multicast/Unicast IP Address** field, within the range 224.0.0.0 through 239.255.255.255.
6. Enter the port number in the **Destination UDP Port** field.

### Audio

1. Locate the **Audio** section.
2. Click the **Source** drop-down list and select the HDMI source.



**NOTE:** If AES67 audio will be used, refer to [AES67 Audio \(page 29\)](#) for more information.

3. Click the **Enable Audio** toggle switch and make sure it is enabled (green). To disable audio at any time, click the toggle switch so that it appears gray.
4. Enter the specific destination IP address, if desired, in the **Destination Multicast/Unicast IP Address** field. By default, AMS will automatically populate this field.
5. Enter the port number in the **Destination UDP Port** field.









**IMPORTANT:** AMS does not allow the same port numbers to be used on both video and audio. Always specify unique ports for both video and audio.

# Basic Operation

## LED Indicators

The following table provides a listing of front-panel LED indicators and their status:

LED		Description
PWR	Off 	<ul style="list-style-type: none"> <li>If using a PoE switch, make sure that the port on the switch that is connected to the encoder, has PoE enabled. When the encoder is powered using PoE, the <b>PWR</b> indicator will be green.</li> <li>Check the Ethernet cable for possible damage or loose connections.</li> </ul>
	Red 	<ul style="list-style-type: none"> <li>The encoder is booting.</li> </ul>
	Green 	<ul style="list-style-type: none"> <li>The encoder is ready.</li> </ul>
HDMI	Red 	<ul style="list-style-type: none"> <li>No source is connected to the input.</li> <li>Check the HDMI cable for possible damage or loose connections.</li> </ul>
	Green 	<ul style="list-style-type: none"> <li>The link integrity between the source and the encoder is good.</li> </ul>
LINK	Red 	<ul style="list-style-type: none"> <li>Check the Ethernet cable for possible damage or loose connections.</li> </ul>
	Green 	<ul style="list-style-type: none"> <li>Link integrity is good between the encoder and the network.</li> </ul>

## Rebooting OmniStream

To reboot the OmniStream encoder, press and release the recessed button, on the far-right side of the unit, using a small, pointed object. Rebooting the encoder does not reset the encoder to factory-default settings.

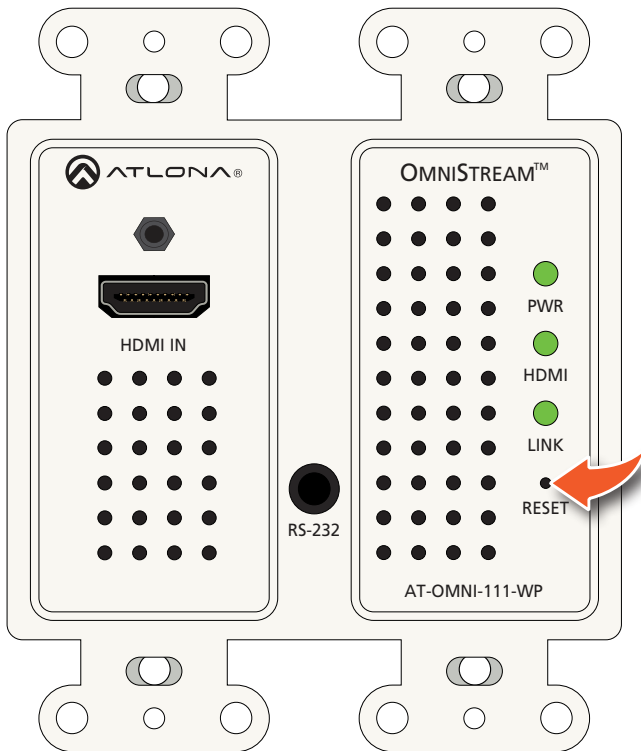

## Unicast Mode

The term *unicast* is used to describe a configuration where information is sent from an encoder to a single decoder. Although it is common to have multiple encoder and decoder units within a system, it may also be desirable to restrict a single encoder to communicate with one decoder. In *unicast* mode, OmniStream encoders and decoders function similar to an n x 1 switcher. Changing the destination IP address at the encoder, will direct the stream to be received by a different decoder.

The illustration below shows three encoders and three decoders on a network, operating in *unicast* mode. The red lines indicate the data paths from each encoder to a separate (single) decoder.



**NOTE:** By default, both encoders and decoders are shipped in multicast mode.

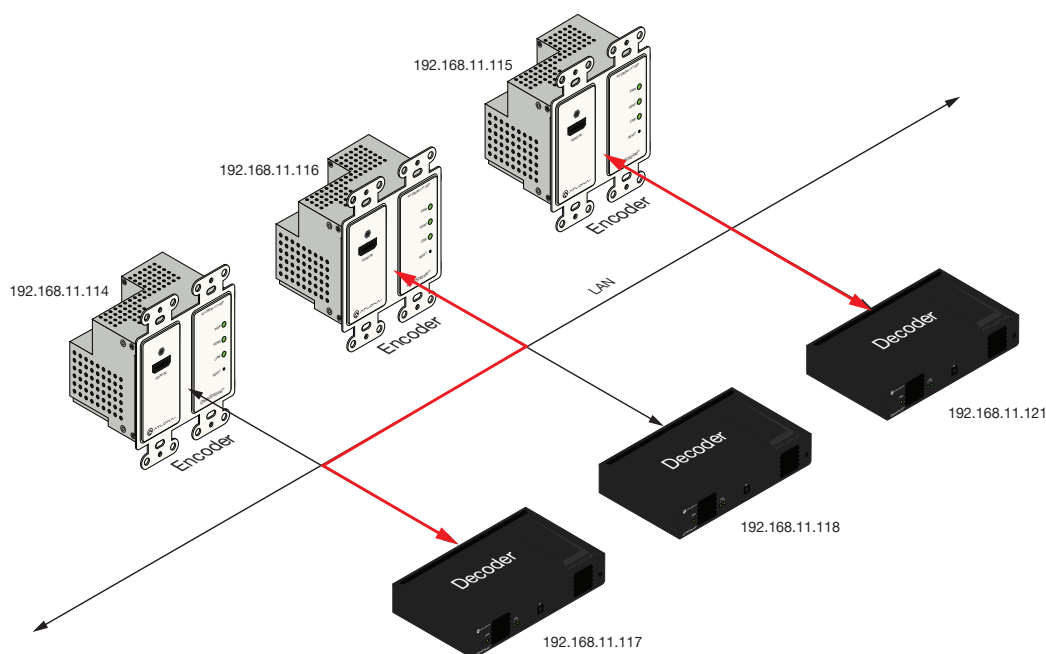

1. Login to AMS. Refer to [Accessing Encoders in AMS \(page 12\)](#), if necessary.
2. Click **SESSION** in the menu bar and locate the **Video** section.
3. Enter the IP address of the decoder in the **Destination Multicast/Unicast Address** field.

Encoder:	HDMI Input 1
Enable Video:	<input checked="" type="checkbox"/>
Destination Multicast/Unicast Address:	225.0.0.5
Destination UDP Port:	1000
TTL:	255

IP address of decoder

←

4. Scroll down to the bottom of the page and click the **SAVE** button to commit all changes.

5. Go to the decoder AMS interface. Refer to the *OmniStream Single-Channel / Dual Channel A/V Decoder User Manual*, if necessary.
6. Click **IP INPUT** from the menu.
7. Remove the IP address from the **Multicast Address** field.
8. Click the **SAVE** button to commit changes.



**IP Input 1 (Video 1)**

Enabled:

Interface: eth1

Multicast Address:

Port: 4

**SAVE**

Field should be blank

9. Unicast setup is complete. The decoder unit will now receive streams exclusively from the encoder containing the IP address of this decoder.

### Multicast Mode

The term *multicast* is used to describe a configuration where information is sent from one or more points to a set of other points. For example, a single encoder can transmit data to multiple decoders. In addition, if multiple encoders are used, each encoder can stream data to any decoder that is not already receiving data from an encoder. In *multicast* mode, the OmniStream encoders and decoders function similar to a matrix switcher.

The illustration below shows three encoders and three decoders on a network, operating in *multicast* mode, where multiple decoders are subscribed to a single encoder. The red lines indicate the data paths from an encoder (192.168.11.117) to multiple decoders.



**NOTE:** By default, both encoders and decoders are shipped in multicast mode.

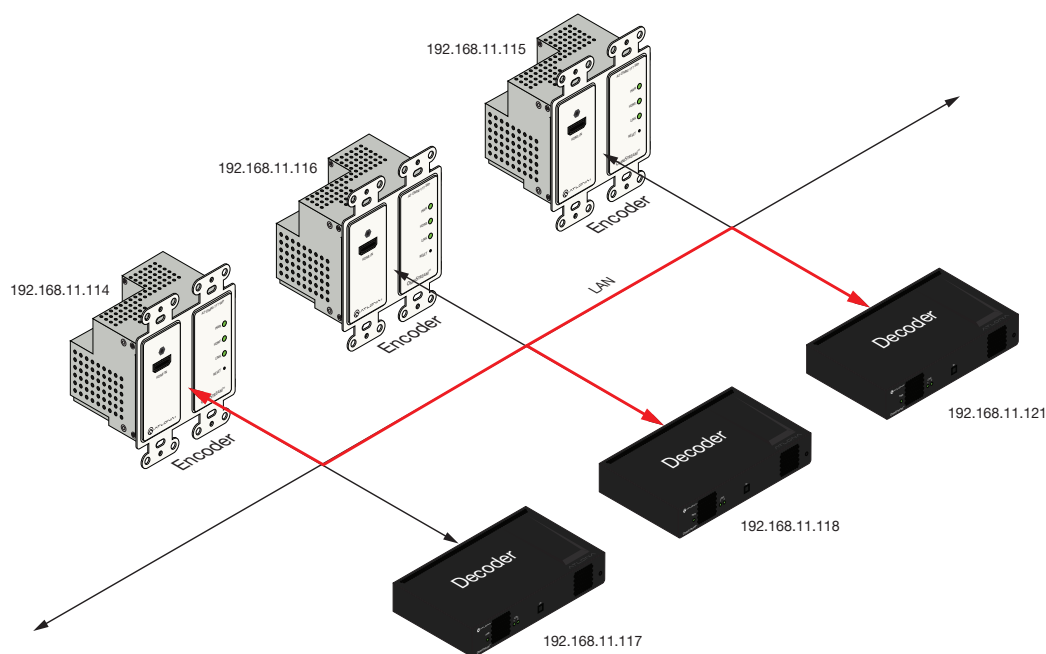

1. Login to AMS. Refer to [Accessing Encoders in AMS \(page 12\)](#), if necessary.
2. The AMS Dashboard will be displayed.
3. Click the  icon, in the upper-left corner of the AMS Dashboard.
4. Click **Virtual Matrix** from the fly-out menu. Refer to [The Virtual Matrix \(page 60\)](#), if necessary.
5. Locate the desired encoder in the Virtual Matrix, as shown on the next page.
6. Create a cross-connection to the desired decoder. When a cross-connection is created, AMS will automatically assign a multicast IP address to both the encoder and decoder. By default, AMS automatically assigns a multicast IP address to each OmniStream encoder and decoder.





Refer to the illustration on the following page, if necessary.



### OmniStream Virtual Matrix

Encoders / Decoders **LEGEND**

Encoder / Decoder	IP Address	Status	AT-OMNI-121	Andrew's AT-OMNI-122	AT-OMNI-122	AT-OMNI-521
AT-OMNI-121 192.168.11.34 at-omni-121-00461	192.168.11.34	Connected	HDMI 1	HDMI 1	HDMI 2	HDMI 1
Andrew's AT-OMNI-122 192.168.11.117 at-omni-122-00548	192.168.11.117	Connected	HDMI 1	HDMI 1	HDMI 2	HDMI 1
AT-OMNI-122 192.168.11.86 192.168.11.87 at-omni-122-00242	192.168.11.86 192.168.11.87	Connected	HDMI 1	HDMI 2	HDMI 1	HDMI 2
AT-OMNI-521 192.168.11.39 at-omni-521-00064	192.168.11.39	Connected	HDMI 1	HDMI 1	HDMI 2	HDMI 1
AT-OMNI-111 192.168.11.50 at-omni-111-00200	192.168.11.50	Connected	HDMI 1	HDMI 1	HDMI 2	HDMI 1
AT-OMNI-112 192.168.11.178 at-omni-112-00349	192.168.11.178	Connected	HDMI 1	HDMI 2	HDMI 1	HDMI 2
Andrew's AT-OMNI-112 192.168.11.116 at-omni-112-00722	192.168.11.116	Connected	HDMI 1	HDMI 2	HDMI 1	HDMI 2
AT-OMNI-116 192.168.11.164 at-omni-116-00122	192.168.11.164	Connected	HDMI 1	HDMI 2	HDMI 1	HDMI 2







### 802.1X Authentication

802.1X is a server-based port authentication which restricts unauthorized (rogue) clients from connecting to a Local Area Network through a public port. In its simplest form, 802.1X usually involves three parties: supplicant (client device), authenticator (Ethernet switch or WAP), and an authentication server. Before the device is permitted on the network, port communication is restricted to Extensible Authentication Protocol over LAN (EAPOL) traffic. If the device passes the authentication process, the authentication server notifies the switch, allowing the client to access the LAN. The illustration below shows the basic architecture.

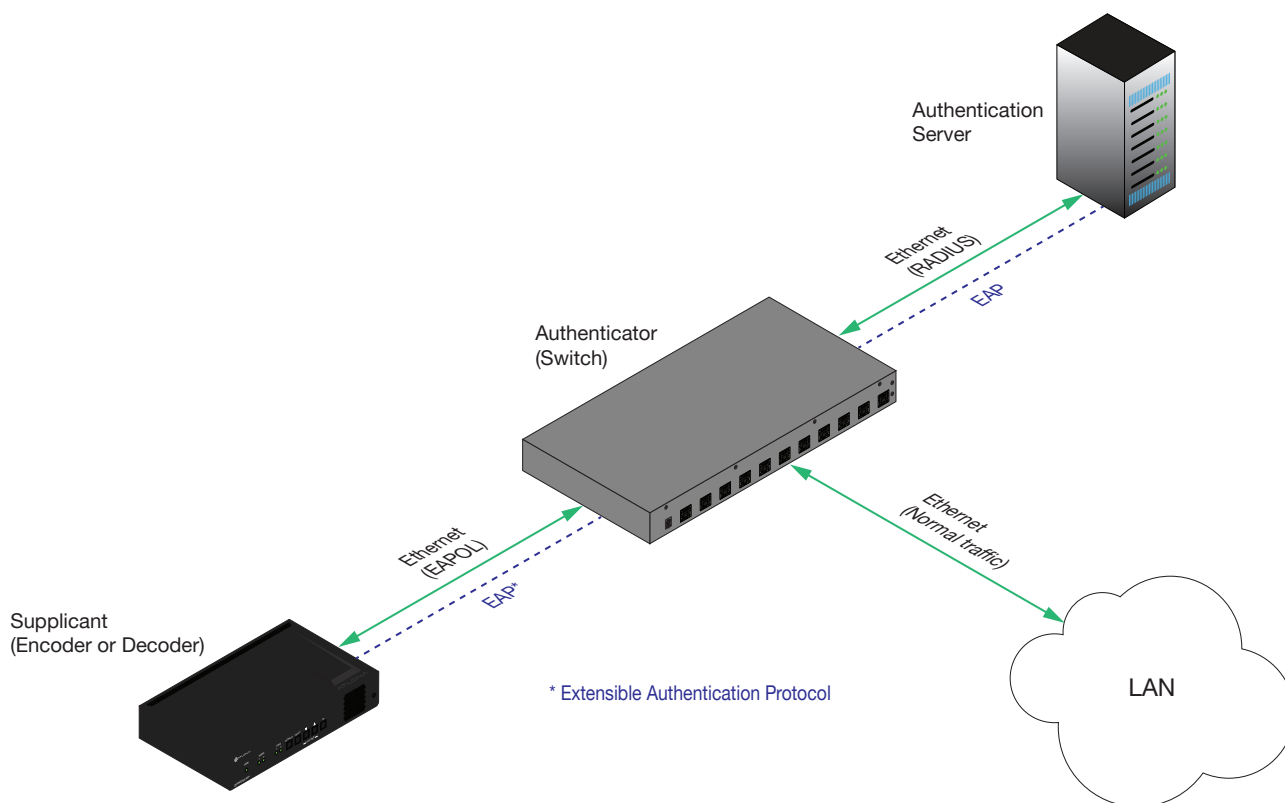

**WARNING:** Connecting an 802.1X-enabled encoder to a network without an active or operational authentication server, will result in an encoder that does not function until the expected message is returned from a RADIUS server. If it is unclear as to whether the network uses 802.1X authentication, consult the IT administrator for assistance.



Three options are available on both the OmniStream encoder and decoder.

Protocol	Description
none	802.1X protocol disabled
PEAP/MSCHAPv2	Protected EAP; requires basic credentials in addition to a CA (certificate authority) certificate.
EAP-TLS	EAP Transport Layer Security; requires a client certificate, client private key, and CA (certificate authority) certificate.

1. Login to AMS. Refer to [Accessing Encoders in AMS \(page 12\)](#), if necessary.
2. Click **Devices** > **All** and select the desired encoder from the **Device List**.
3. Click **NETWORK** in the menu bar.
4. Click the **SHOW ADVANCED** button to expand the options under both **Network** window groups.
5. Click the **802.1x Mode** drop-down list, at the bottom of the page, and select the desired authentication method. In the example below, **PEAP/MSCHAPv2** is selected.

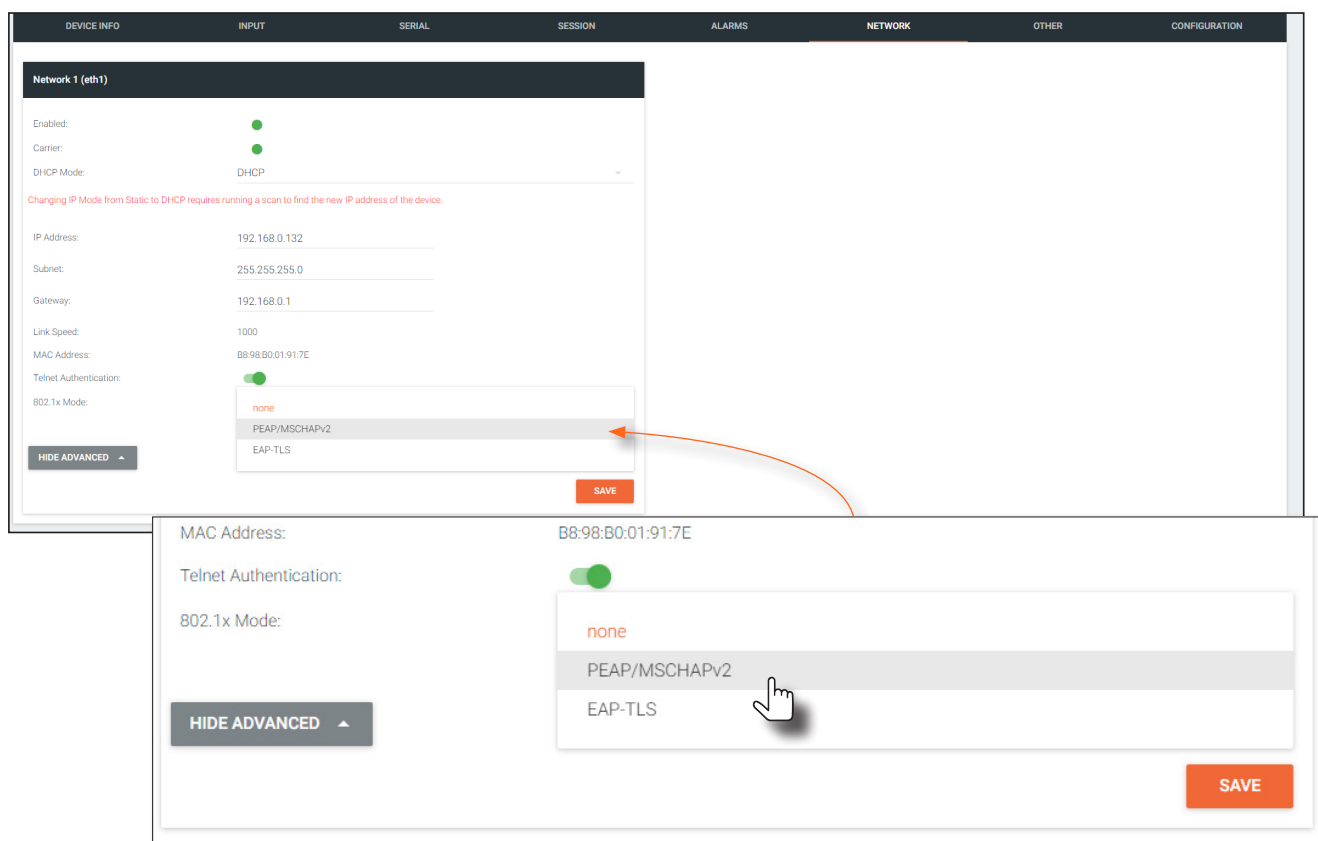

6. Once a method is selected, the required fields for that method will be displayed. Enter the required information in each field. For the **PEAP/MSCHAPv2** option, the fields are described as follows:
  - **Identity**  
Enter the identity of the authentication server in this field. PEAP uses this field to identify the correct authentication server which will process the credentials. For example, if `foo@authserv.com` is entered, then this identifies AUTHSERV as the RADIUS (authentication) server.
  - **CA certificate**  
Click the **Browse...** button to select the certification authority (CA) certificate. To remove a certificate, click the **Remove** button.
  - **Username**  
Enter the username in this field
  - **Password**  
Enter the password in this field.
7. Click **SAVE** to commit changes.

MAC Address: B8:98:60:01:90:22

Telnet Authentication:

802.1x Mode: PEAP/MSCHAPv2

Identity: foo@server.com

Password: t0ughpA55w0rd

CA certificate: |

**HIDE ADVANCED** ▲

**SAVE**

8. Refer to the table below for a list of available authentication methods. An orange dot indicates that this field will be displayed as part of the method.

Authentication Method	Identity	Password	CA Certificate	CA Certificate	Client Private Certificate
PEAP/MSCHAPv2	●	●	●		
EAP-TLS			●	●	●

9. 802.1X authentication configuration is complete. If desired, click the **HIDE ADVANCED** button to collapse the options under both **Network** window groups.

### AES67 Audio

AES67 audio is a standard for high-performance audio streaming over IP, providing several features such as synchronization, media clock identification, and connection management. AES67 does not support compressed audio formats, such as Dolby® Digital, and others. Source audio must be transmitted as LPCM 2.0 or 5.1.

1. Login to AMS. Refer to [Accessing Encoders in AMS \(page 12\)](#), if necessary.
2. Click **Devices** > **All** and select the desired encoder from the **Device List**.
3. Click **SESSION** in the menu bar.
4. Locate the **Audio** section, under the desired **Stream**, and click the **Enable AES67** toggle switch to enable this feature. When enabled, the toggle switch will be green.

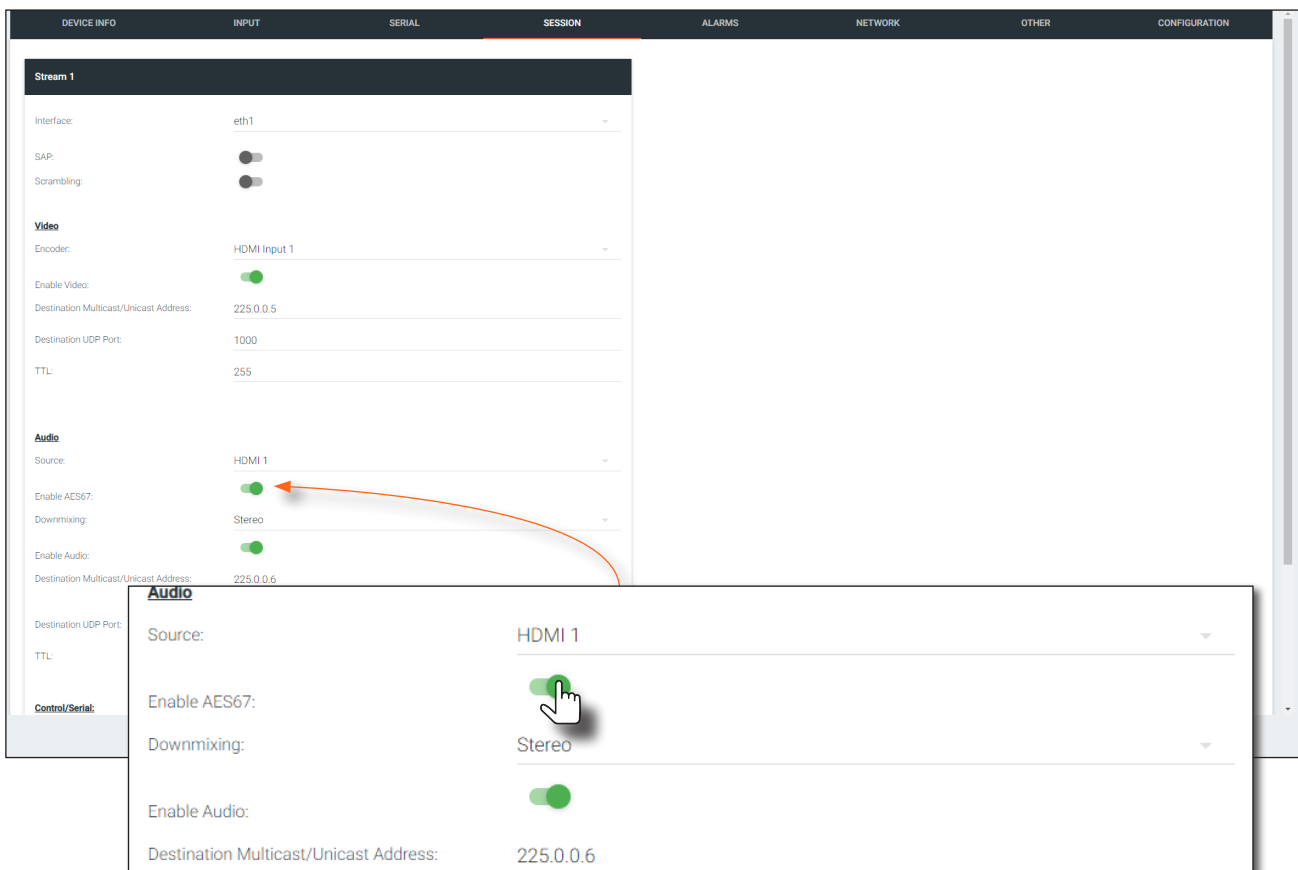

5. Select the type of downmixing from the **Downmixing** drop-down list, if desired. Available options are: **None**, **Mono**, or **Stereo**.
6. Click the **SAVE** button within the **Stream** window group.
7. Go to the decoder interface and click **OTHER** in the menu bar.
8. Click **SAP** in near the upper-left corner of the AMS screen.
9. Click the **Enable** toggle switch to enable SAP. When enabled, the toggle switch will be green. Refer to the *OmniStream Single-Channel / Dual Channel A/V Decoder User Manual*, if necessary. If the decoder is to receive AES67 audio, this step is *required*.
10. Click the **SAVE** button on the **SAP** page.

## EDID Management

OmniStream encoders provide EDID management for each input. The encoder can be assigned one of several included EDID presets or can be assigned a custom EDID. Raw EDID data can be copied from displays or other sink devices, that are connected to OmniStream decoders.

### Selecting an EDID Preset

1. Login to AMS. Refer to [Accessing Encoders in AMS \(page 12\)](#), if necessary.
2. Click **INPUT** in the menu bar.
3. Click the **EDID** drop-down list, within the desired **HDMI Input** window group, and select the EDID.

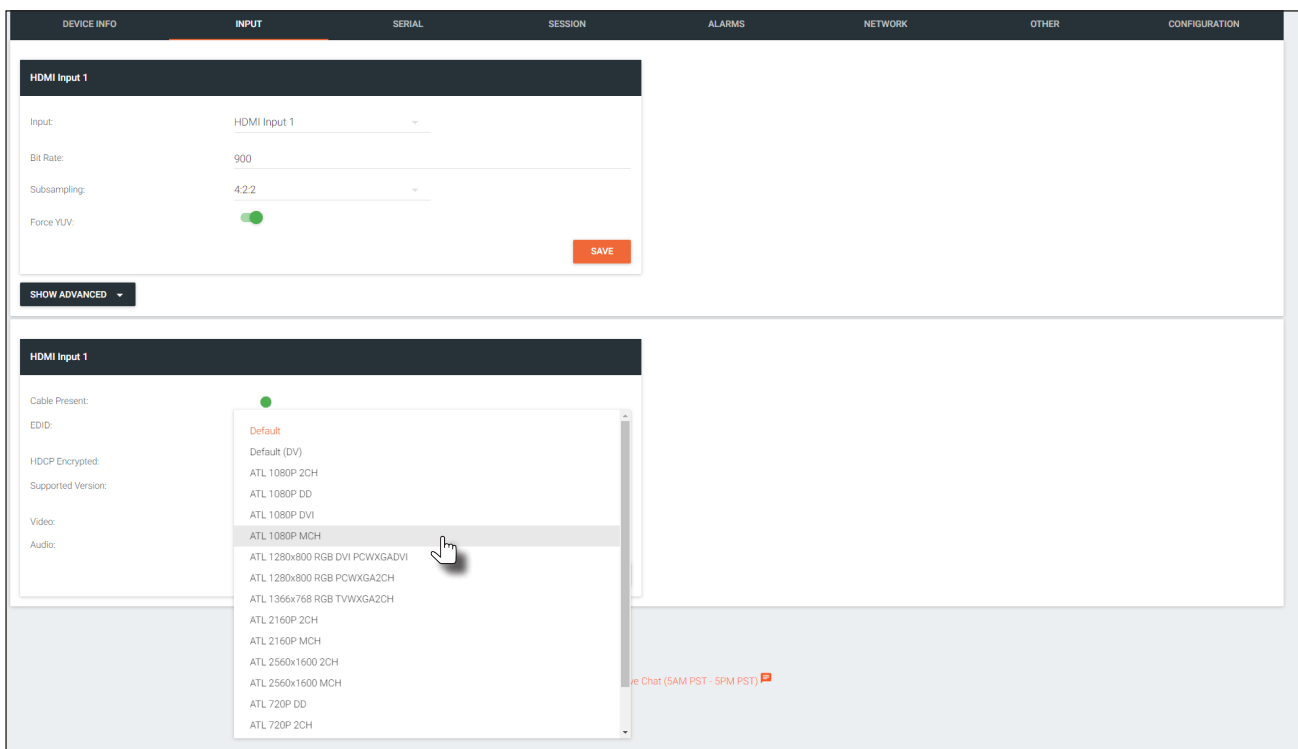

4. Click the **SAVE** button to commit changes.

### Using a Custom EDID

Encoders can be assigned a custom EDID. The raw EDID data must be in hexadecimal format. Commas or spaces can be included as delimiters to separate each hexadecimal value.

1. Login to AMS. Refer to [Accessing Encoders in AMS \(page 12\)](#), if necessary.
2. Click **INPUT** in the menu bar.
3. Click the **EDID** drop-down list.
4. Scroll down to the bottom of the list and select **+ Add Custom EDID**.
5. Enter the name of the EDID in the **EDID Name field**. Spaces and special character are valid entries. Use a descriptive name for this field.

### Add Custom EDID

EDID Name  
3840 x 2160 YUV 60 Hz

---

Raw EDID  
|

Raw EDID

---

CANCEL
SUBMIT

6. Enter the EDID data in the **Raw EDID** field. EDID data can be copy and pasted from an EDID editor and must be in hexadecimal format. Commas or spaces can be included as delimiters to separate each hexadecimal value.
7. Click the **SUBMIT** button to commit changes or click **CANCEL** to abort the addition of a custom EDID. Once a custom EDID is created, it will be added to the drop-down list and can be selected without re-entering the information.

The following tables provide a list of which EDID to use with each video mode. Note that the available EDID selections will depend upon the current video mode. Refer to [Setting the Video Mode \(page 39\)](#) for more information.

### Common

EDID	2CH LPCM	MCH LPCM	DTS	Dolby	Dolby Digital*	DTS-HD MA <sup>†</sup>	Dolby True HD*
1080P 2CH	Yes	No	No	No	No	No	No
1080P DD	No	No	Yes	Yes	No	No	No
1080P MCH	No	Yes	Yes	Yes	Yes	Yes	Yes

### PC application mode only

EDID	2CH LPCM	MCH LPCM	DTS	Dolby	Dolby Digital*	DTS-HD MA <sup>†</sup>	Dolby True HD*
Default	Yes	No	Yes	Yes	Yes	Yes	Yes
1080P DVI	No	No	No	No	No	No	No
1280x800 RGB DVI PCWXGADVI	No	No	No	No	No	No	No
1280x800 RGB PCWXGA2CH	Yes	No	No	No	No	No	No
1366x768 RGB TVWXGA2CH	Yes	No	No	No	No	No	No
2160P 2CH	Yes	No	No	No	No	No	No
2160P MCH	No	Yes	Yes	Yes	Yes	No	No
2560x1600 2CH	Yes	No	No	No	No	No	No
2560x1600 MCH	No	Yes	Yes	Yes	Yes	No	No

### Video mode only

EDID	2CH LPCM	MCH LPCM	DTS	Dolby	Dolby Digital*	DTS-HD MA †	Dolby True HD*
Default -Video Mode	No	Yes	Yes	Yes	Yes	Yes	Yes
Default - Video Mode (No HDR)	No	Yes	Yes	Yes	Yes	Yes	Yes
4K60 MCH	No	Yes	Yes	Yes	Yes	Yes	Yes
4K60 PCM-MCH	No	Yes	No	No	No	No	No
460 LPCM 2CH	Yes	No	Yes	Yes	Yes	Yes	Yes
720P DD	No	No	Yes	Yes	No	No	No
720P 2CH	Yes	No	No	No	No	No	No

\* Dolby Atmos® is carried with either Dolby Digital Plus or Dolby True HD audio streams.

† DTS:X is carried with DTS-HD MA audio streams.

### Copying an EDID from the Display

In order to allow the source device to send all AV formats that are supported by the display device, the EDID from the decoder must be copied to the encoder. Access to a decoder will be required.

1. Login to AMS and access the desired decoder. Refer to [Accessing Encoders in AMS \(page 12\)](#) except instead of clicking on an encoder, click on a decoder (AT-OMNI-121, AT-OMNI-122, or AT-OMNI-521).
2. Make sure the display, where the EDID will be fetched, is connected to the decoder. Select the desired decoder from within AMS.
3. Click **HDMI OUTPUT** in the menu bar.

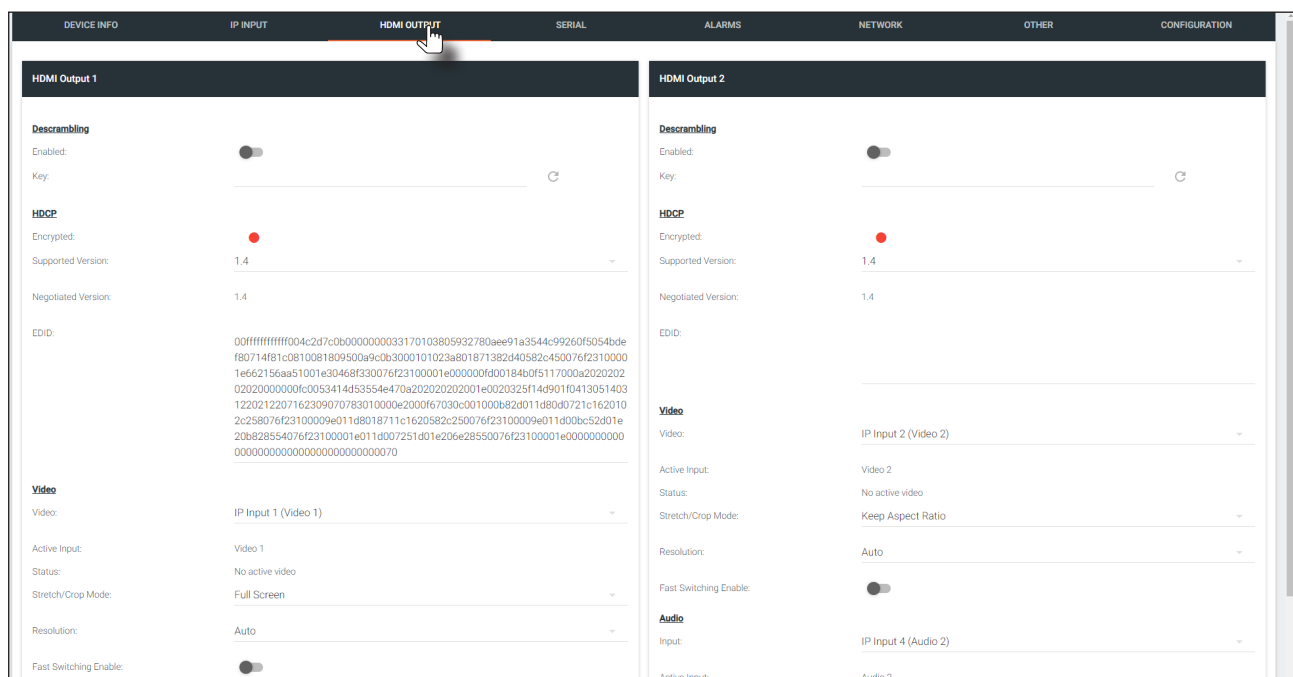



4. Locate the **EDID** section. This is the EDID of the display which is connected to the decoder. Click and select the data in this field, then press [CTRL]+[C] to copy the data.

**HDMI Output 1**

**Descrambling**  
Enabled:   
Key:

**HDCP**  
Encrypted:   
Supported Version: 1.4  
Negotiated Version: 1.4

**EDID:**  
00ffffffff004c2d7c0b000000033170103805932780aee91a3544c99260f5054bde  
f80714f81c0810081809500a9c0b3000101023a801871382d40582c450076f2310000  
1e662156aa51001e30468f330076f23100001e00000fd00184b0f5117000a2020202  
0202000000fc0053414d53554e470a202020202001e0020325f14d901f0413051403  
122021220716230907078301000e2000f67030c001000b82d011d80d0721c162010  
2c258076f23100009e011d8018711c1620582c250076f23100009e011d00bc52d01e  
20b828554076f23100001e011d007251d01e206e28550076f23100001e000000000  
00000000000000000000000000000070

5. Select the desired encoder, within AMS.
6. Click **INPUT** in the menu bar.
7. Click the **EDID** drop-down list, in the desired **HDMI Input** window group.
8. Scroll down to the bottom of the list and select **+ Add Custom EDID**.

Input: HDMI Input 1  
Bit Rate: 900  
Subsampling: 4:2:2  
Force YUV:

**SHOW ADVANCED**

**HDMI Input 1**  
Cable Present:   
EDID:   
HDCP Encrypted:   
Supported Version:   
Video:   
Audio:

EDID List:  
ATL 1080P 2CH  
ATL 1080P DD  
ATL 1080P DVI  
ATL 1080P MCH  
ATL 1280x800 RGB DVI PCWXGADVI  
ATL 1280x800 RGB PCWXGA2CH  
ATL 1366x768 RGB TVWXGA2CH  
ATL 2160P 2CH  
ATL 2160P MCH  
ATL 2560x1600 2CH  
ATL 2560x1600 MCH  
ATL 720P DD  
ATL 720P 2CH  
ATL VR (2160x1200)  
**+ Add Custom EDID**

9. Enter the name of the EDID in the **EDID Name field**. Spaces and special character are valid entries. Use a descriptive name for this field.
10. Paste the EDID data into the **Raw EDID** field by pressing [CTRL]+[V].
11. Click the **SUBMIT** button to commit changes or click **CANCEL** to abort the addition of the custom EDID. Once a custom EDID is created, it will be added to the drop-down list and can be selected without re-entering the information.

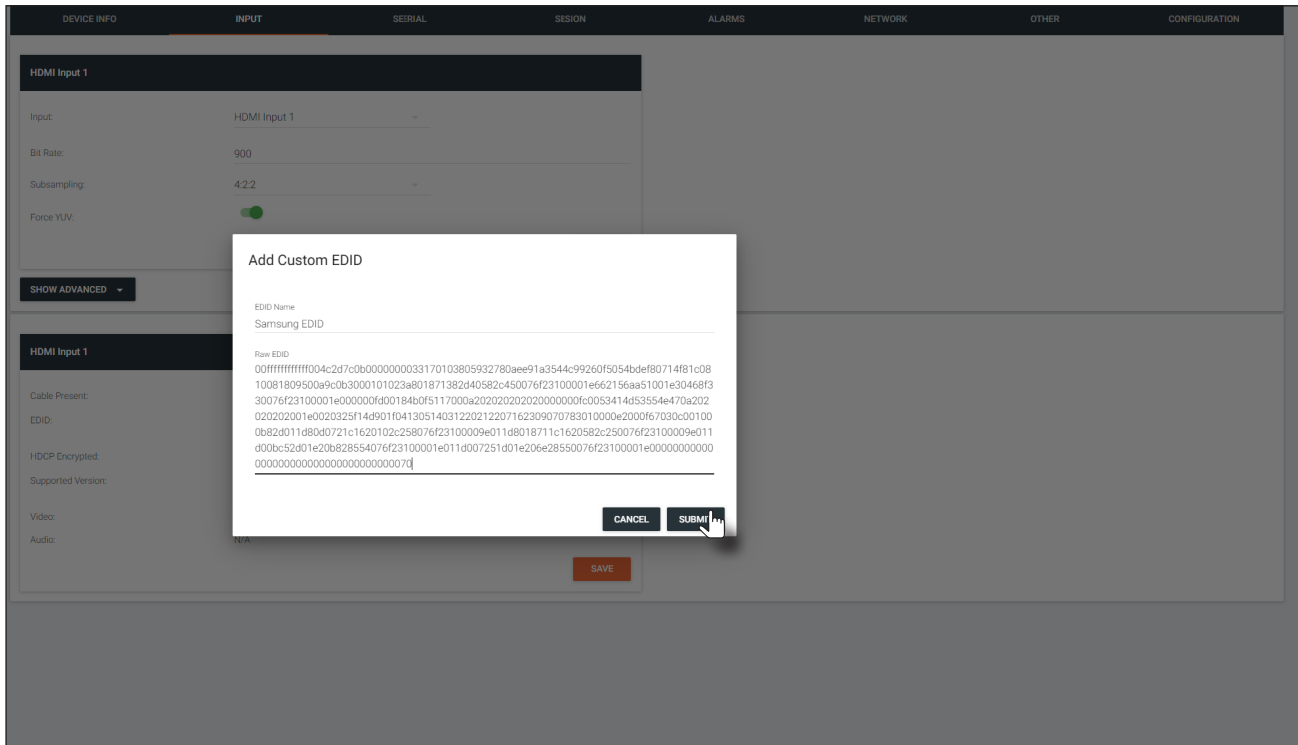

## Encoder Grouping

Grouping encoders allows a group of encoders to feed a single decoder, simultaneously. The stream will be displayed by the decoder using either manual or automatic input-selection, based on the presence of a source signal.

1. Login to AMS. Refer to [Accessing Encoders in AMS \(page 12\)](#), if necessary.
2. Click **SESSION** in the menu bar.
3. Click the **SHOW ADVANCED** button to expand options for the desired **Stream**.
4. Locate **Encoder Groups** and enter a name for the group in the **Group Name** field. The default group names for **Stream 1** is **session1**.

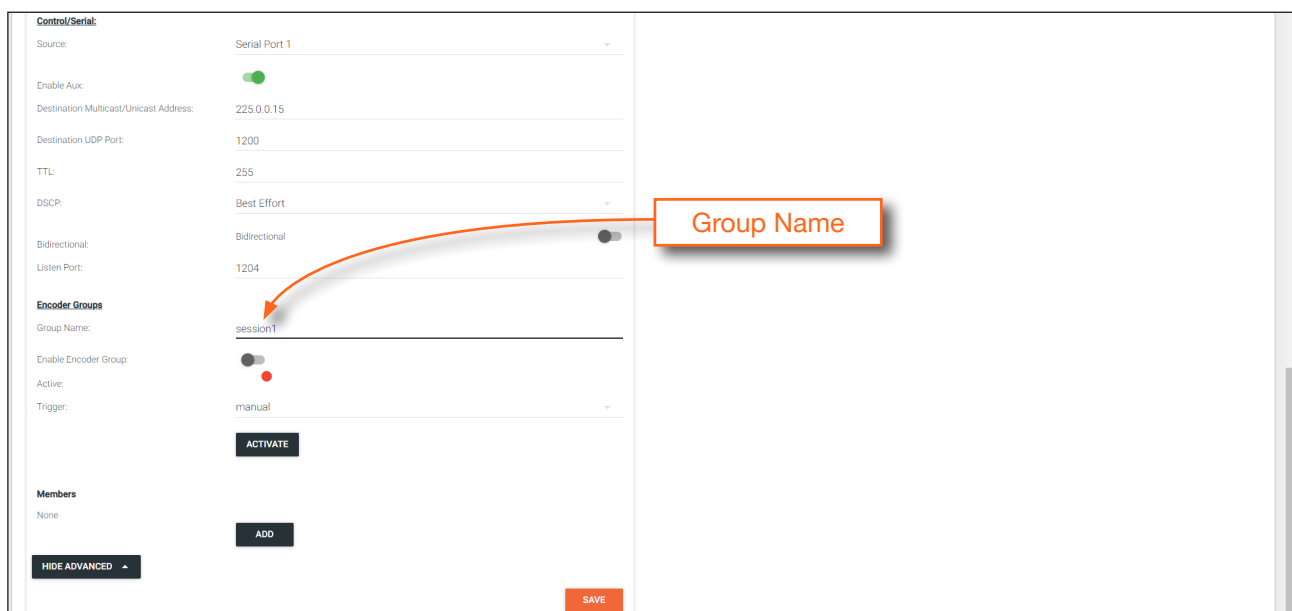

5. Under **Members**, click the **ADD** button and enter the IP address of the encoder to be added to the group.
6. Click the **Interface** drop-down list to select the desired interface.
7. Click the **SUBMIT** button to commit changes to the encoder group.
8. Repeat steps 5 through 8 for each encoder to be added to the encoder group.

 **IMPORTANT:** The IP address for each encoder must be added to the group. This includes the IP address of the encoder that is being used to create the group.

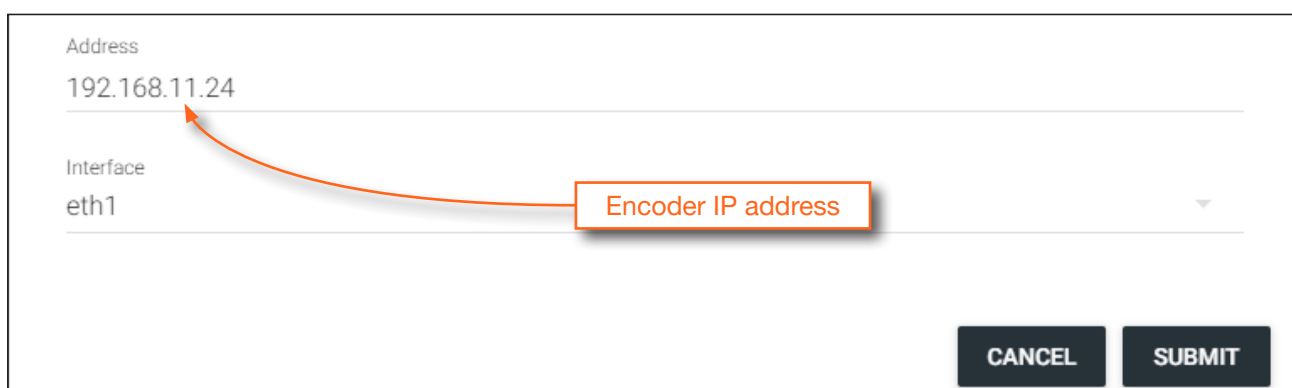

- Click the **Enable Encoder Group** toggle switch to enable encoder grouping. When enabled, this toggle switch will be green.
- Click the **Trigger** drop-down list and select the desired trigger mode.

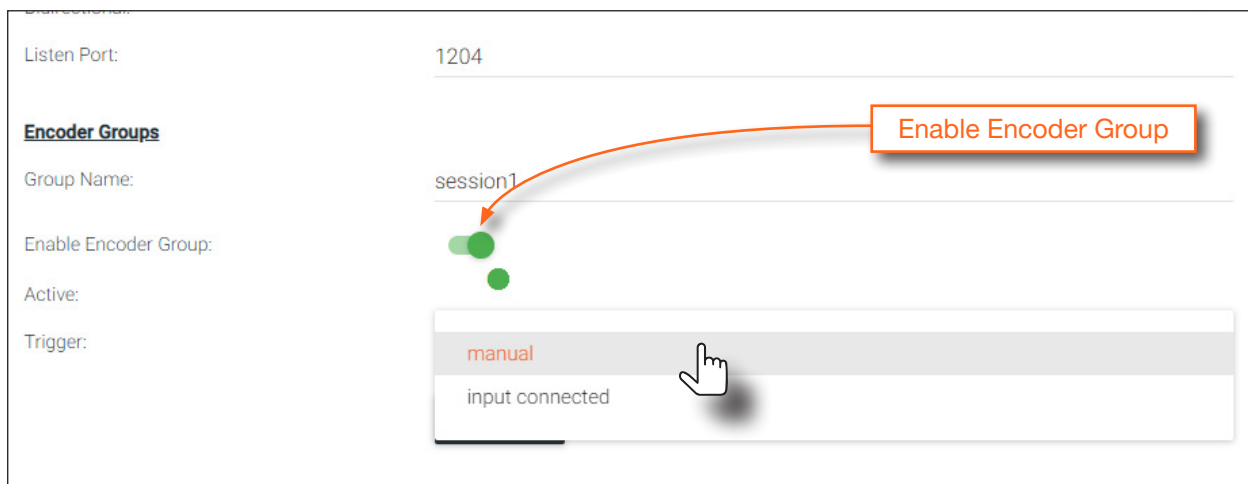

Mode	Description
manual	Use this setting to manually enable the input. When set to manual, click the <b>Activate</b> button to perform the input switching.
input connected	Use this setting to allow the encoder group to use automatic input detection. Once a new source is connected, that source becomes the active source.



**NOTE:** Setting **Trigger** to **input connected** should not be used when **Slate Mode** is set to **Auto**. Doing so will cause the slate to be displayed when switching inputs. If encoder auto-switching is being used, set the **Slate Mode** to **Auto**, on the decoder. Refer to [Slate / Logo Insertion \(page 40\)](#) for more information.

- Click the **SAVE** button, at the bottom of the **Stream** window group to commit all changes.

## Scrambling

OmniStream supports 128-bit Advanced Encryption Standard (AES) scrambling for both audio and video streams. Scrambling can be enabled or disabled through AMS, and can be individually applied to video, audio, or both. Scrambling can be enabled either before or after the decoding process is started. Data streams cannot be scrambled. By default, scrambling is disabled.

### Standard Method

1. Login to AMS. Refer to [Accessing Encoders in AMS \(page 12\)](#), if necessary.
2. Click **SESSION** in the menu bar.
3. Under the desired **Stream**, click the **Scrambling** toggle switch to enable it. Once enabled, the toggle switch will be green and the **Key** field will be displayed.

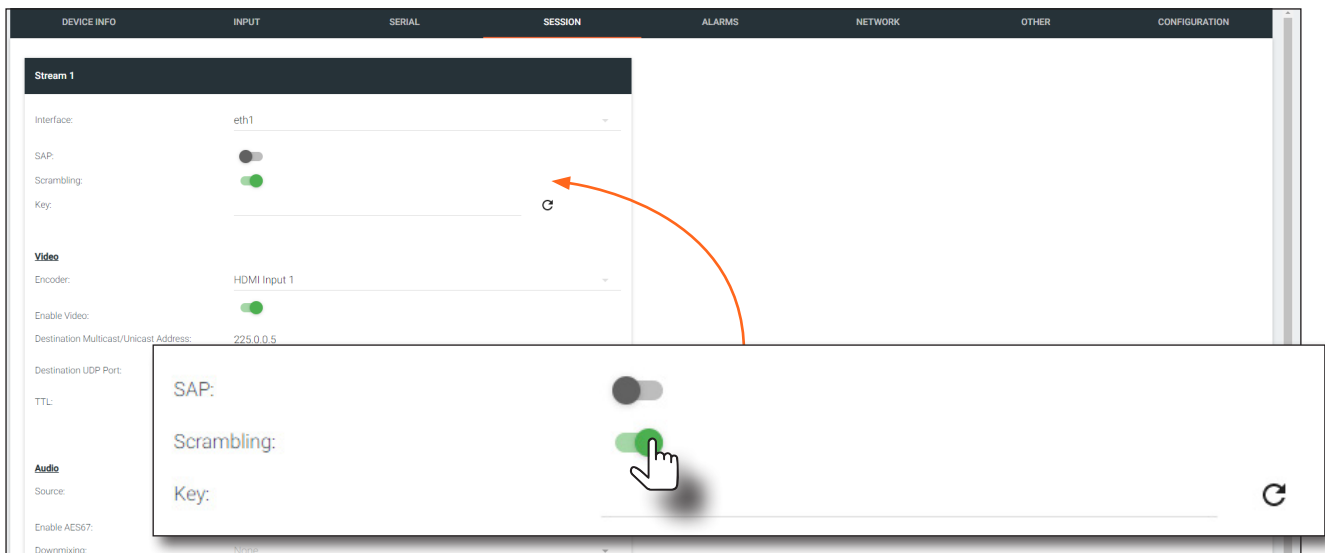

4. Enter the desired scrambling key in the **Key** field. If a random key is desired, click the  icon to generate a key. Each time this icon is clicked, a new scrambling key will be generated.







**IMPORTANT:** If a user-defined key is specified, then it must be a minimum of eight alphanumeric characters. Special characters and spaces are not permitted. Also note that if a key is generated, the same generated key (on the encoder) must also be used on the decoder, in order to de-scramble the signal.

5. Click the **Save** button at the bottom of the page to commit the changes.

### Using the Virtual Matrix

1. Access the Virtual Matrix. Refer to [The Virtual Matrix \(page 60\)](#) for more information.
2. Locate the desired encoder or decoder. Scrambling is managed on the encoder; descrambling is managed on the decoder.
3. Click the key icon. The Scrambling dialog box will be displayed. If the key icon for a decoder is clicked, then the Descrambling dialog box will be displayed.

<b>AT-OMNI-112</b> 10.20.40.26 10.20.40.26 at-omni-112-0041 <b>Connected</b> 	HDMI 1 In	
	HDMI 2 In	
<b>AT-OMNI-512</b> 10.20.40.17	HDMI 1 In	

4. Click the **Enable** toggle switch to enable scrambling for the desired session.

### Scrambling - AT-OMNI-111 : 192.168.0.132

Session: session1

Enable  

Key  

CLOSE
SAVE

5. Enter the desired scrambling key using one of the following methods:
  - Manual enter a user-defined key in the **Key** field.
  - Click the  icon to generate a random key using AMS. Each time this icon is clicked, a new scrambling key will be generated.
6. Repeat the above process for each session.
7. Click the **Save** button to commit the changes.

### Setting the Video Mode

OmniStream offers two video modes: Video and PC application. These two modes will optimize the video, based on the type of information that is being displayed. Use the **Video** mode when display motion graphics/video. Set this mode to **PC application** when viewing static images, such as spreadsheets or similar content.

 **IMPORTANT:** In order to use 3840x2160p60 signals, **Video Optimization** must be set to **Motion Video**.

1. Login to AMS. Refer to [Accessing Encoders in AMS \(page 12\)](#), if necessary.
2. Click **INPUT** in the menu bar.
3. Click the **SHOW ADVANCED** button, under the **HDMI Input 1** window group.
4. Click the **Video Optimization** drop-down list to select the desired mode.

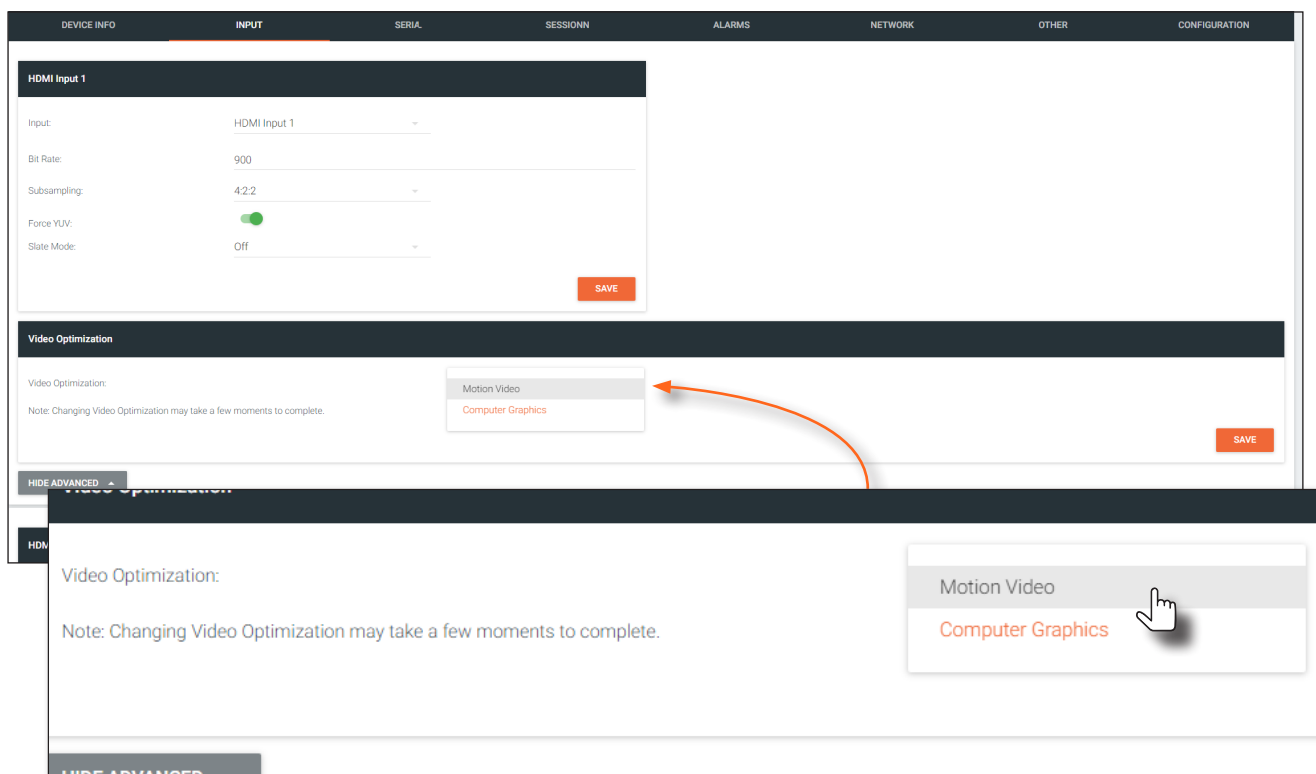

Mode	Description
Computer Graphics	Optimizes the image when viewing static images, such as spreadsheets or similar content.
Motion Video	Provides the best viewing experience when streaming motion graphics and/or video.

4. Click the **SAVE** button, within the **Video Optimization** window group to commit changes. Note that switching between video modes may take a few moments to complete.
5. Go to the decoder interface and repeat the process. Refer to the *OmniStream Single-Channel / Dual Channel A/V Decoder User Manual*, if necessary.

## Slate / Logo Insertion

Slate / logo insertion is managed from within AMS. The difference between a “slate” and “logo” is in the size of the image and how it is used: Logos are classified as smaller, low-resolution images that can be positioned at specified locations on the screen. Slates occupy the entire screen. Note that while logos may be used as slates, the image quality will be degraded, as the image will be scaled to fill the screen.

Slate / logo insertion can be performed on both the encoder and decoder. When configured on the encoder, the image that is displayed on the output (decoder) will be from the encoder IP address(es) to which each decoder is subscribed. When configured on the decoder, the image is unique to the specified HDMI output. Refer to the *OmniStream Single-Channel / Dual Channel A/V Decoder User Manual*, for information on managing slate / logo insertion on decoder units.

### Adding Slates / Logos

1. Login to AMS. Refer to [Accessing Encoders in AMS \(page 12\)](#), if necessary.
2. Click **OTHER** in the menu bar.
3. Verify that **Logo** is selected, near the upper-left corner of the screen. **Logo** is the default selection and applies to both logo and slate images.
4. Enter the name of the image in the **Name** field. If a name is not specified, then the **UPLOAD** button will be disabled.
5. Under the **New logo** window group, click the **Choose File** button and select the image to be used. Only .png files are valid selections.
6. Click the **UPLOAD** button to upload the file.

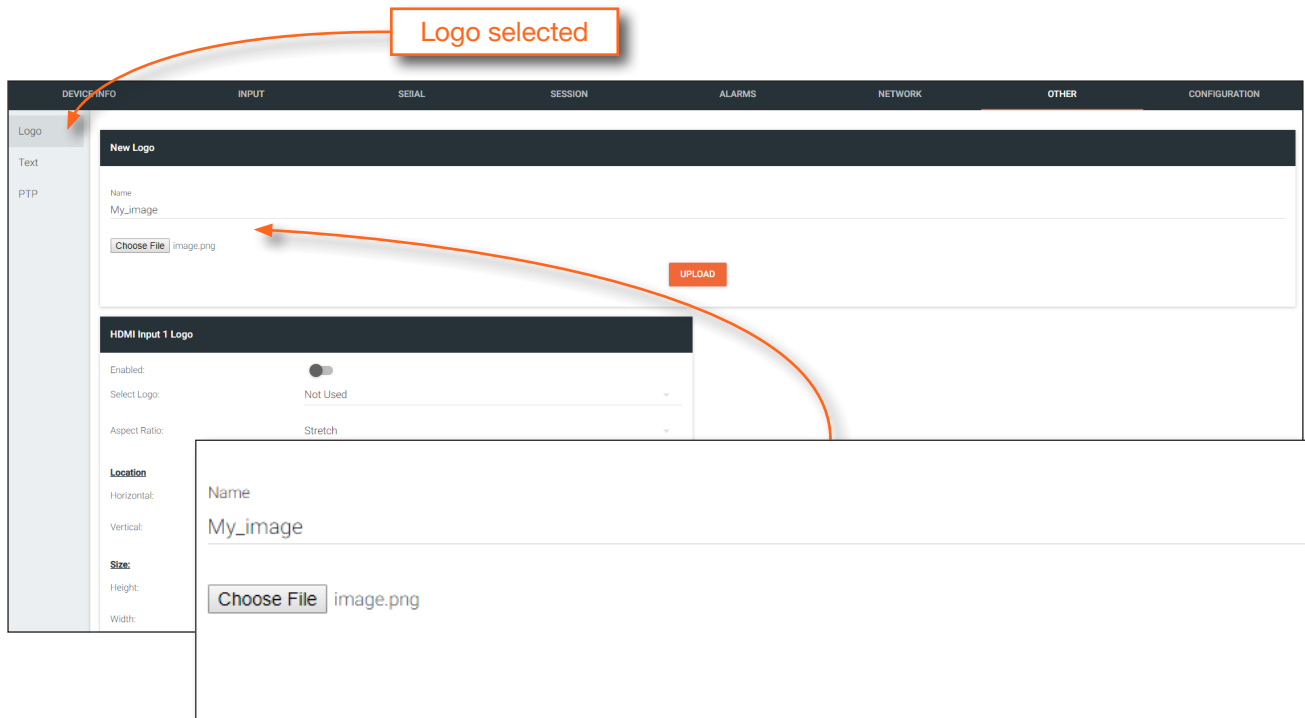

7. A new window group will be created with the name of the logo that was provided in Step 4.



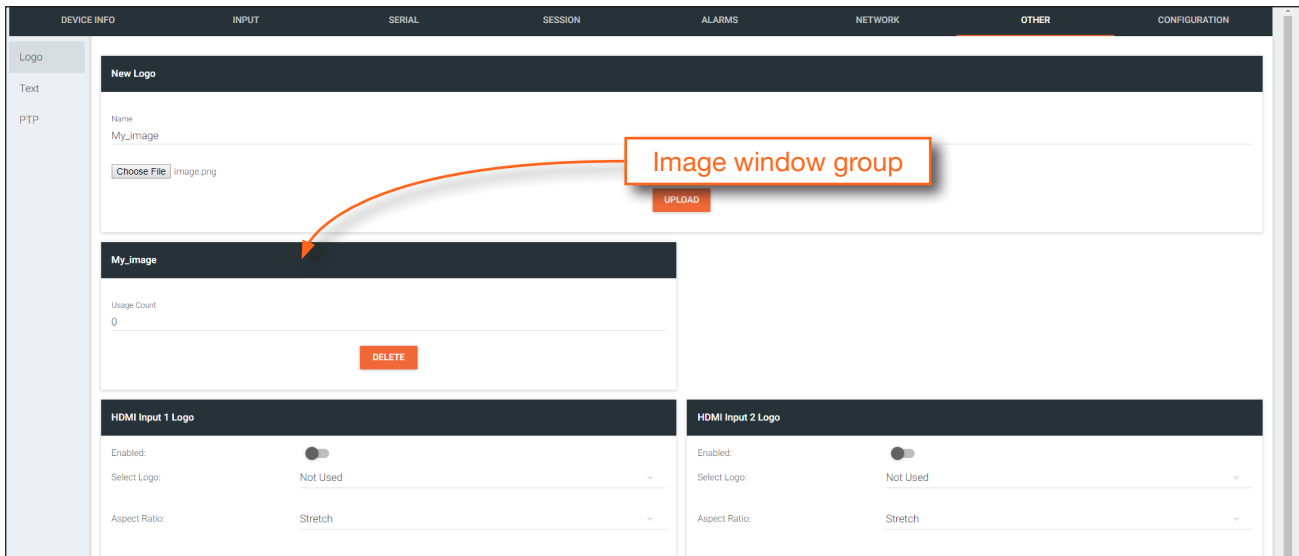

8. Perform one of the following:

- If the selected image will be used as a *logo*, then proceed with Steps 9 through 13.
- If the image will be used as a *slate*, skip to Step 14.

9. Under the **HDMI Input Logo** window group, click the **Select Logo** drop-down list and select the desired logo. To prevent the image from being displayed, select the **Not used** option.

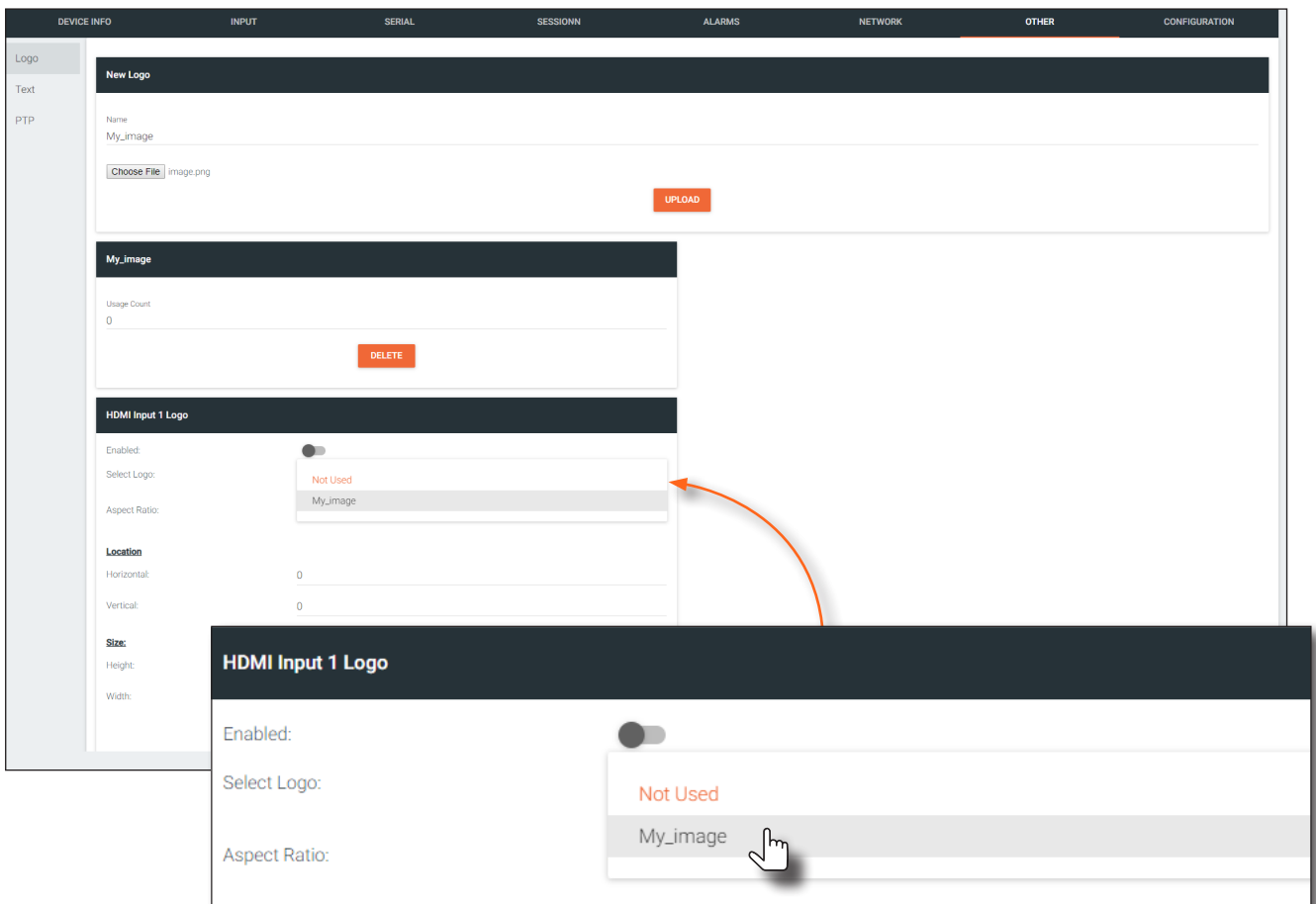

10. Click the **Aspect Ratio** drop-down list to set the aspect ratio of the image. Selecting **Keep** will maintain the aspect ratio. Select **Stretch** to scale the image to fill the screen.
11. Enter the location of the on-screen image, in pixel values, by entering the desired values in the **Horizontal** and **Vertical** fields.
12. Click the **Enabled** toggle switch to activate the logo/slate feature. When enabled, this toggle switch will be green.
13. Click the **SAVE** button to commit changes.
14. Click **INPUT** in the menu bar, then click the **SHOW ADVANCED** button.
15. Click the **Slate mode** drop-down list, and select **Off**, **Manual**, or **Auto**.

Mode	Description
Off	Disables the image from being displayed.
Manual	The image will always be displayed, superimposed on the source signal, and will remain even if the source signal is lost.
Auto	The image will only be displayed when the source signal is lost. For example, this mode is useful in conference room applications for displaying system instructions when no sources are connected.

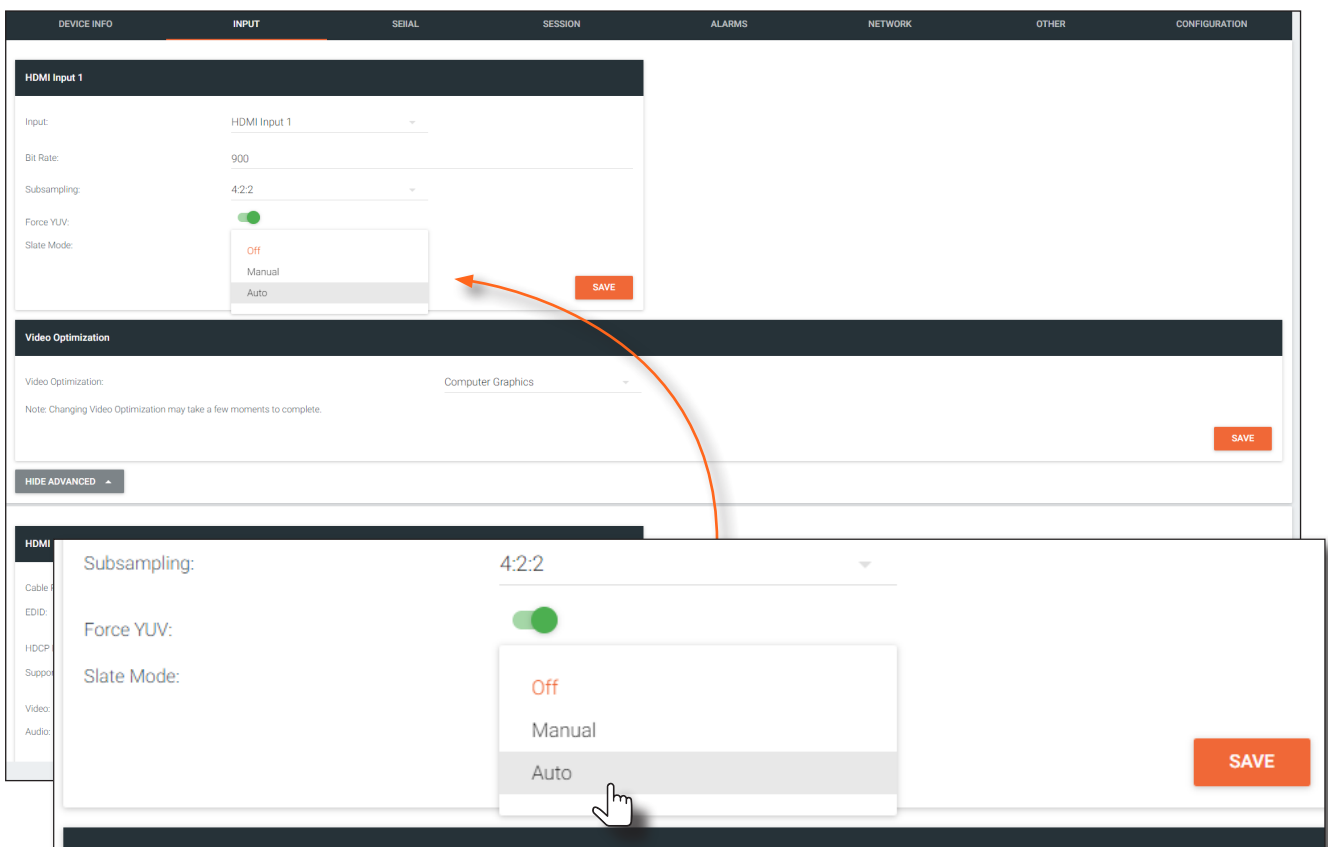

16. Click the **Slate Logo** drop-down list and select the desired image. Note that if **Slate Mode** is set to **Off**, then this field will not be visible.
17. Click the **SAVE** button to apply all changes.

### Deleting Slates / Logos

Follow the instructions below to remove a logo/slate image.

1. Click **OTHER** in the menu bar.
2. Click the **DELETE** button in the desired image window group. When the **DELETE** button is clicked, the window group and the associated image will be deleted from the encoder. If the **DELETE** button is disabled, do the following:
  - a. Locate the **HDMI Input Logo** window groups.
  - b. Click the **Select Logo** drop-down list and select **Not Used**.
  - c. Click the **SAVE** button.
  - d. Refresh the page.
  - e. Click the **DELETE** button to remove the logo.

## Text Insertion

1. Login to AMS. Refer to [Accessing Encoders in AMS \(page 12\)](#), if necessary.
2. Click **OTHER** in the menu bar.
3. Click **Text** in the side menu bar, in the upper-left corner of the AMS screen.
4. Click the **Enabled** toggle switch, to allow the text to be displayed. When enabled, this toggle switch will be green.

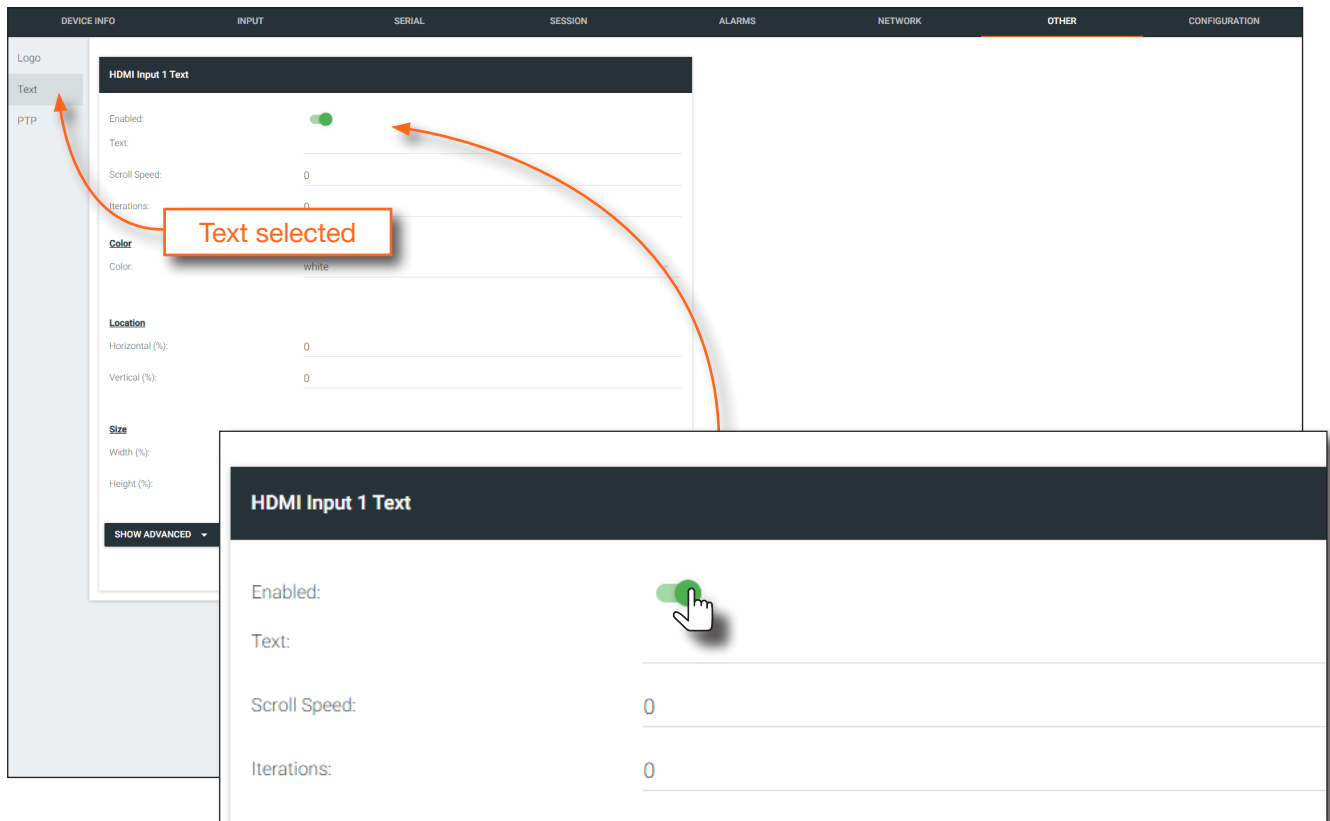

4. In the **Text** field, enter the desired text.
5. Specify the speed of the scrolling text in the **Scroll Speed** field. Values from -255 to 255 are valid. Negative numbers will scroll the text from left to right. Positive numbers will scroll text from right to left.
6. Enter the number of iterations in the **Iteration** field. Set this field to 0 (zero) to set the number of iterations to infinity.
7. Click the **Color** drop-down list to select the color of the text. The **Red**, **Green**, and **Blue** fields can be changed to further modify the color of the text. Adjust the **Alpha** field to control the transparency of the text. A value of 255 is opaque and a value of 0 is transparent. Numbers from 0 to 255 are valid for each of these fields.
8. Specify the location of the text in the **Horizontal (%)** and **Vertical (%)** fields. Each of these values is based on the horizontal and vertical resolution of the screen.
9. Specify the size of the text in the **Width (%)** and **Height (%)** fields. Each of these values is based on the horizontal and vertical resolution of the screen.
10. Click the **SAVE** button to commit all changes.

# The AMS Interface

## Device Info page

The **Device Info** page provides general information about the encoder.

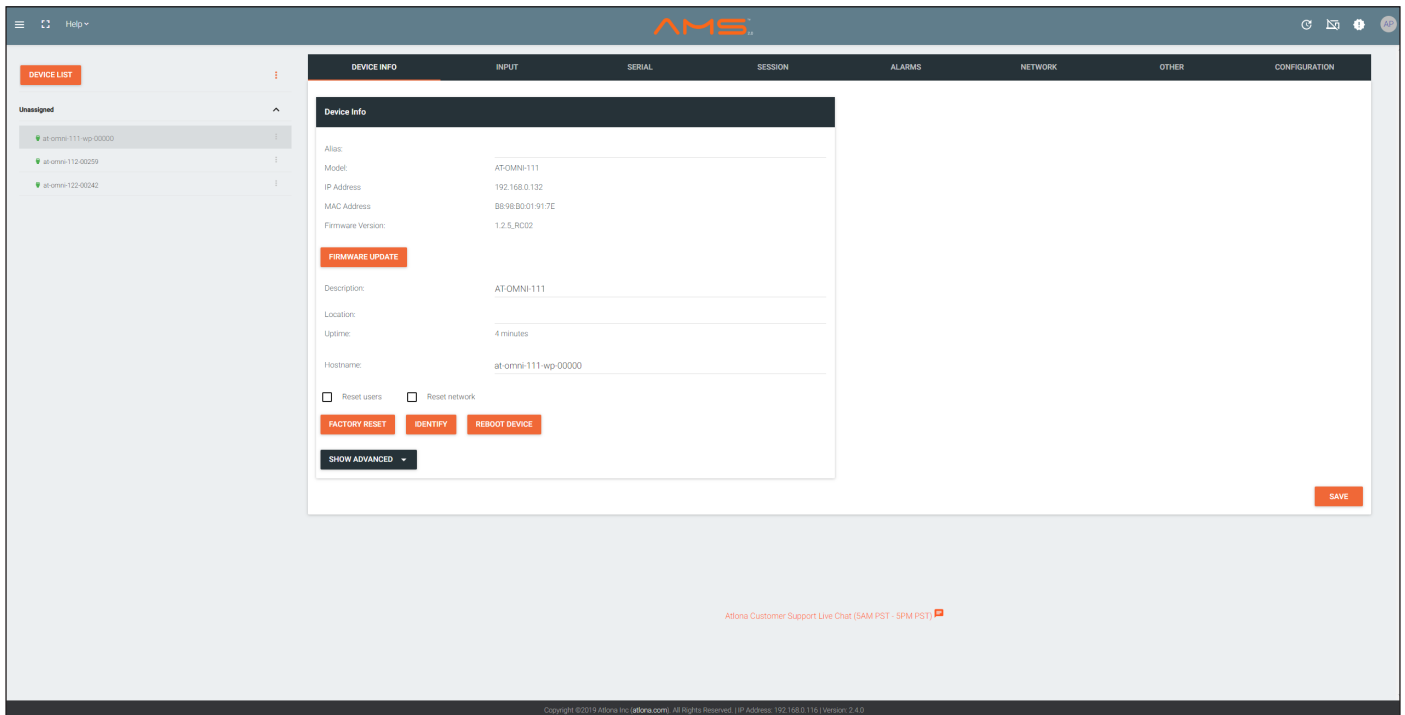

### Alias

Enter a name for the unit in this field. This is optional.

### Model

The model number of the unit. The OmniStream Wallplate will use the name AT-OMNI-111-WP.

### IP Address

Displays the IP address of the encoder.

### MAC Address

Displays the MAC address of the encoder.

### Firmware version

The version of firmware that the encoder is running. Always make sure the latest version of firmware is installed.

### FIRMWARE UPDATE

Click this button to update the firmware.

### Description

Provides the option of assigning descriptive name to the unit.

### Location

Provides the option of assigning descriptor for the location of the unit.

### Uptime

Time elapsed since the last reboot operation.

### Hostname

The hostname of this unit. This can be changed if desired. By default, the host name is automatically created using the model of the unit and adding the last five digits of the unit serial number.

### FACTORY RESET

Click this button to reset the encoder to factory-default settings. When performing a factory reset, the following options can be selected, by clicking the check box. If no options are selected, then the encoder is reset with no factory-default settings.

Option	Description
None Checked	Resets the encoder with no factory-default settings.
Reset User	Resets the encoder to factory-default settings and resets custom user information.
Reset Network	Resets the encoder to factory-default settings and resets network information.
Reset Defaults	Resets the encoder to factory-default settings. In addition, static multicast addresses are configured. This option can be used to configure a single encoder to transmit to any number of decoders without using the Virtual Matrix within AMS.   <b>IMPORTANT:</b> This option will not work for multiple encoders on the same network.

### IDENTIFY

Click this button to physically identify a unit on the network. Clicking this button will cause all front-panel LED indicators to flash for 10 seconds.

### REBOOT DEVICE

Click this button to perform a soft reboot of the encoder.

### Advanced Settings

Click the **SHOW ADVANCED** button to view the following options.

#### Timezone

Click this drop-down list to select the time zone, expressed in Universal Coordinated Time (UTC).

#### System Temperature

The current internal temperature of the unit listed in both degrees Fahrenheit and Celsius.

#### Die Temperature

The component chip temperature listed in both degrees Fahrenheit and Celsius.

#### Power Consumption

The current power consumption value.

#### NTP Server

Specify the desired NTP server in this field. This provides timestamps for any logs and alarms.

#### Buttons

Disabling this feature will lock the ID button on the front panel. This feature is enabled by default.

#### LEDs

Disabling this feature will turn off all LED indicators on the front panel. This is enabled by default.

## Input page

The **Input** page provides signal information for each channel (input). If using the single-channel encoder, only a single (input) channel will be displayed.

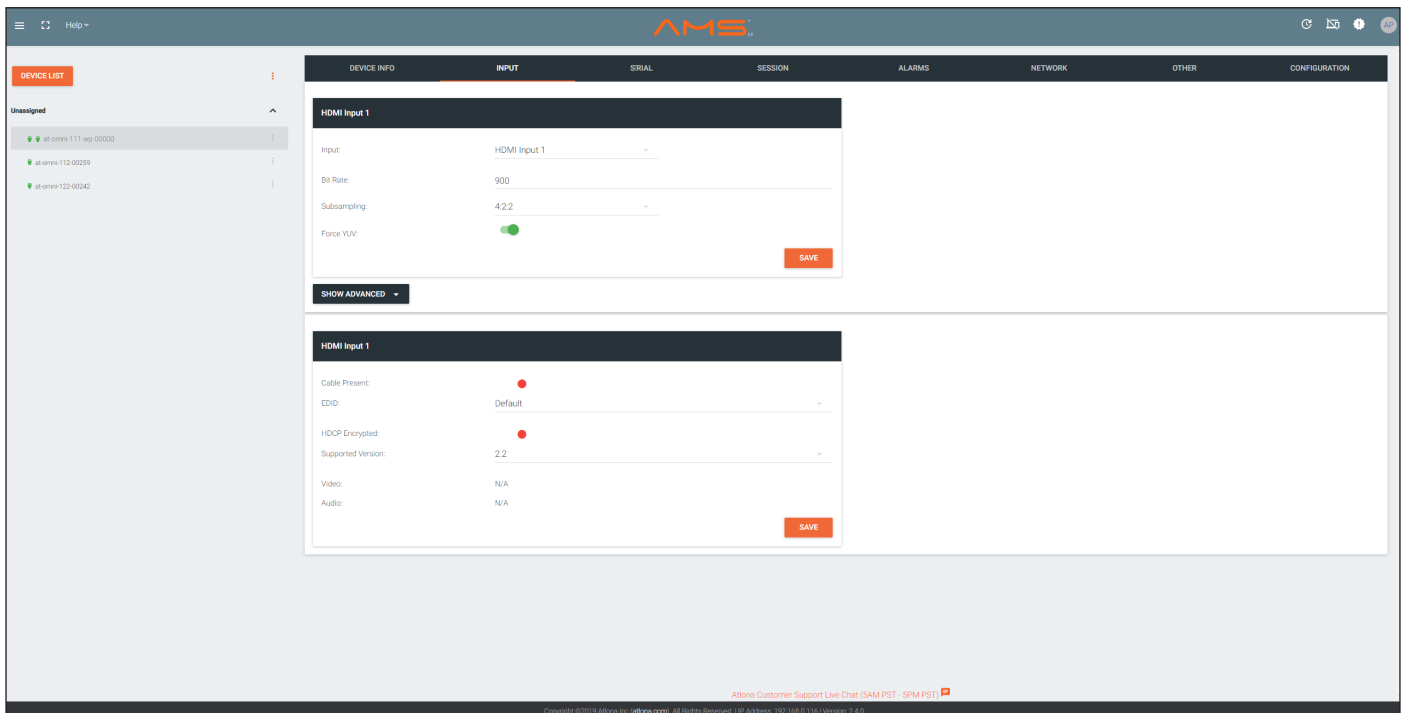

### Input

The selected input. This value can be **HDMI Input 1**, **Video Generator 1**, or **None**.

### Bit Rate

The current video bit rate. Specifying lower bit rates will reduce video quality. This value is in megabits-per-second (Mbps). 4K/UHD streams should be set to 900 Mbps. The recommended bandwidth for 1080p60 video is also 450 Mbps. Setting this field below these recommended values will result in lower-quality video.

### Subsampling

Click this drop-down list to select the desired maximum chroma subsampling value. Any input with a higher chroma subsampling will have their chroma scaled to the configured value using a very high quality chroma scaler to preserve quality.

### Force YUV

When this toggle switch is enabled (green), it will force the output of the decoder to output YUV regardless of whether the input to the encoder is RGB or YUV. In order for the chroma scaling to work on RGB inputs, this option must be enabled.

### Cable Present

Indicates whether or not a connection is detected. The indicator, to the left, indicates the current state. If the indicator is green, then a source signal is detected. If the indicator is red, then check the cable connection and make sure that the source is powered. Damaged cables may also display a red indicator.

### EDID

Click the drop-down list to select the desired EDID. Refer to the table below for a list of available EDID selections.

EDID	Description
Default	Default OmniStream EDID
ATL 1080P 2CH	1920x1080p60 with two-channel PCM audio
ATL 1080P DD	1920x1080p60 with Dolby Digital audio
ATL 1080P DVI	1920x1080p60 with video formatted as DVI
ATL 1080P MCH	1920x1080p60 with multichannel PCM audio
ATL 1280x800 RGB DVI PCWXGADVI	1280x800p60 with video formatted as DVI
ATL 1280x800 RGB PCWXGA2CH	1280x800p60 PC format with two-channel PCM audio
ATL 1280x800 RGB TVWXGA2CH	1280x800p60 TV format with two-channel PCM audio
ATL 2160P 2CH	3840x2160p30 with two-channel PCM audio
ATL 2160P MCH	3840x2160p30 with multichannel PCM audio
ATL 2560x1600 2CH	2560x1600p60 with two-channel PCM audio
ATL 2560x1600 MCH	2560x1600p60 with multichannel PCM audio
ATL 4K60 MCH	3840x2160p60 with multichannel PCM audio
ATL 4K60 PCM_MCH	3840x2160p60 with two-channel / multichannel PCM audio
ATL 720P DD	1280x720p60 with Dolby Digital audio
ATL 720P 2CH	1280x720p60 with Dolby Digital two-channel audio

### HDCP Encrypted

Indicates if the content being transmitted from the source is HDCP-encrypted. If using HDCP-encrypted content is being used, then this indicator will be green.



**NOTE:** Disabling **HDCP compliance** does not decrypt HDCP content.

### Supported Version

Click this drop-down list to select the version of HDCP to be supported: **2.2**, **1.4**, or **None**. If **None** is selected, then HDCP-encrypted content cannot be passed-through.

### Video

The current sampling rate for the input video signal.

### Audio

The sampling frequency for the input audio signal.



### Advanced Settings

Click the **SHOW ADVANCED** button to view the following options.

#### Slate Mode

Click this drop-down list to enable slate mode or select the desired slate to be used. Refer to [Slate / Logo Insertion \(page 40\)](#) for more information.

#### Video Optimization

Sets the output video mode. Refer to [Setting the Video Mode \(page 39\)](#) for more information.

## Serial page



**IMPORTANT:** The AT-OMNI-111-WP does not currently support serial (RS-232) functionality. However, the page is listed within AMS.

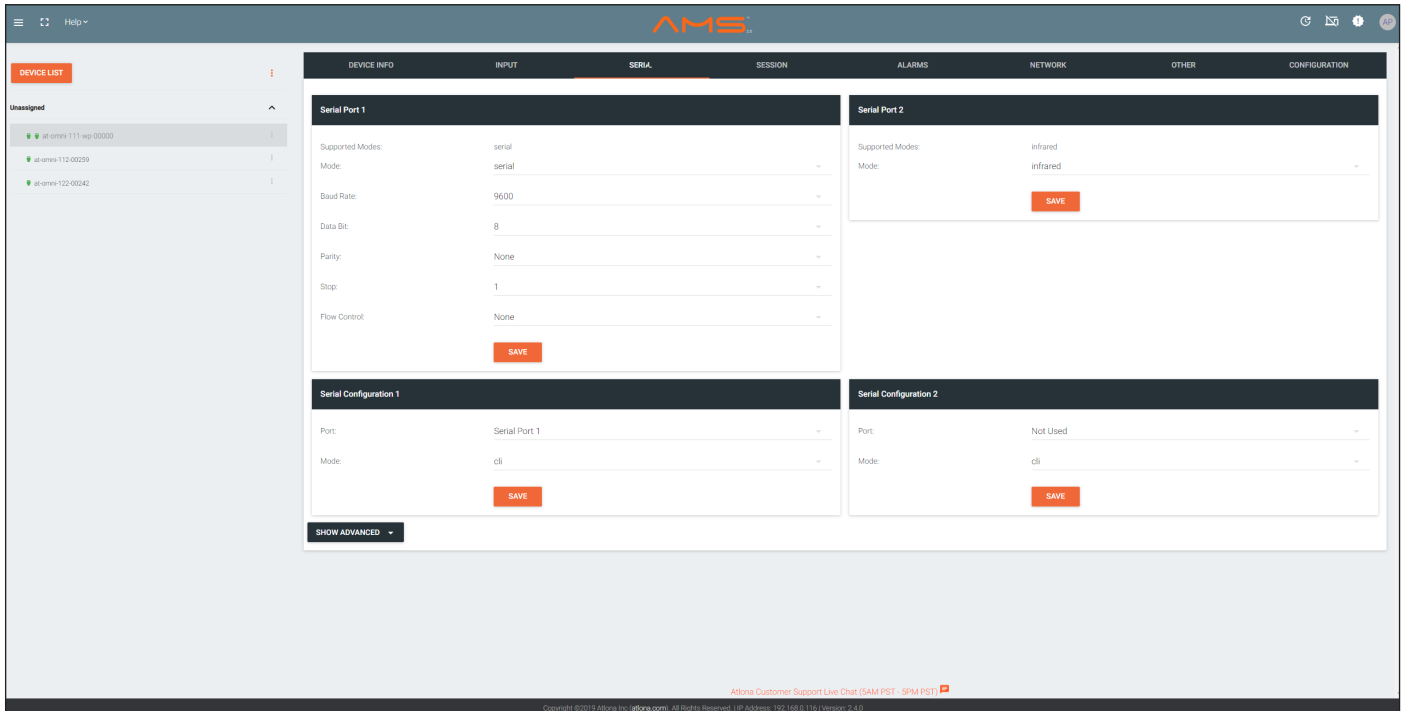

## Session page

The **Session** page provides the ability to configure all session parameters. Up to two sessions are supported on the AT-OMNI-111-WP.

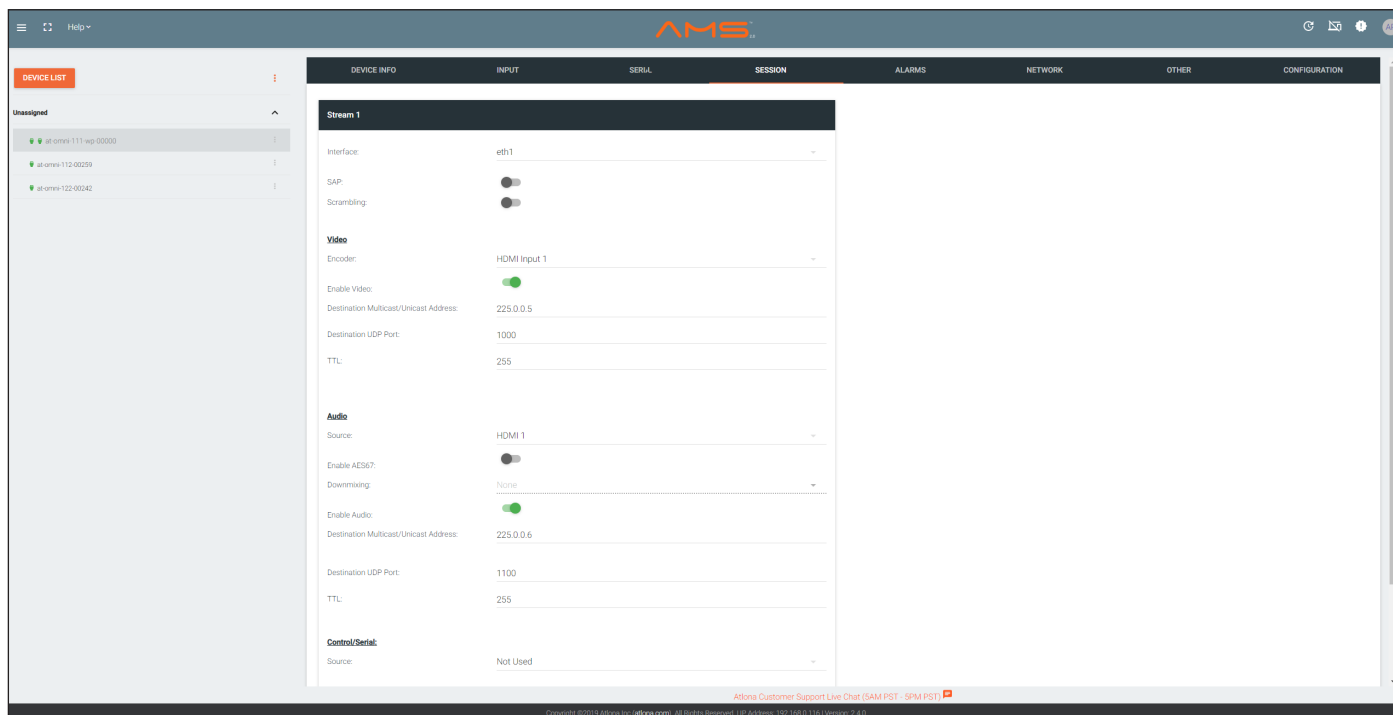

### Interface

Click this drop-down list to select the desired interface.

Interface	Description
eth1	ETHERNET 1 port
Not Used	Ethernet interface is disabled

### SAP

Click this switch to enable to disable the Session Announcement Protocol. When enabled, the toggle switch will be green.

### Scrambling

Click this toggle switch to enable (green) or disable scrambling.

### Key

This field is only displayed if the **Scrambling** toggle switch is enabled (green). Enter the scrambling key in this field. The scrambling key must be ASCII and must contain a minimum of eight characters. Special characters and spaces are not permitted.

### Encoder

Click this drop-down list to select the desired HDMI input.

### Enable Video

Click the toggle switch to enable or disable the video stream. When enabled, the toggle switch will be green. By default, video streaming is *enabled*. Disabling the video stream can be used to “mask” the video on the decoder endpoints.

### Destination Multicast/Unicast Address

Enter the IP address of the decoder that will be receiving the video stream. By default, AMS will automatically populate multicast IP addresses for the encoder.

### Destination UDP Port

Enter the destination UDP port in this field.

### TTL

Set the TTL (Time-To-Live) duration, from 1 to 255 seconds, in this field. The default value is 255 seconds.

### Source

### Input

Select the desired HDMI input from the **Source** drop-down list.

### Enable AES67

Click this toggle switch to enable AES67. When this feature is enabled, the toggle switch will be green.

### Downmixing

This field will only be available when AES67 is enabled.

### Enable Audio

Click the toggle switch to enable the audio stream. By default, audio streaming is *disabled*.

### Destination Multicast/Unicast Address

Enter the IP address of the decoder that will be receiving the audio stream.

### Destination UDP Port

Enter the destination UDP port in this field.

### TTL

Set the TTL (Time-To-Live) duration, from 1 to 255 seconds, in this field. The default value is 255 seconds.

### Source

Click this drop-down list to select the method of how commands are transmitted.



**IMPORTANT:** The AT-OMNI-111-WP does not currently support serial (RS-232) functionality. However, the page is listed within AMS.

### Advanced Settings

Click the **SHOW ADVANCED** button to view the following options. **DSCP**, **FEC Enable**, **FEC Rows**, and **FEC Columns** apply to both **Video** and **Audio** sections.

#### DSCP

Select the Differentiated Services Code Point (DSCP) type from the **DSCP** drop-down list. This value will be used to determine the Quality of Service (QoS) on a network. The available values are: **Best Effort**, **Low**, **Normal**, **High**, and **Highest**. The **Best Effort** setting will provide normal priority for data packets, while a setting of **Highest** will prioritize data packets as critical. However, it should be noted that a higher priority setting may also result in high data packet loss, depending upon network traffic.

#### FEC Enable

Click this toggle switch to enable (green) or disable Forward Error Correction (FEC). This feature can be used when transporting streams over a network that is suspected to be unreliable, due to noise or other factors. By default, this feature is enabled. Refer to [FEC Details \(page 65\)](#) for more information.

#### FEC rows

Specify the number of FEC rows in this field. Refer to [FEC Details \(page 65\)](#) for more information.

#### FEC Columns

Specify the number of FEC columns in this field. Refer to [FEC Details \(page 65\)](#) for more information.

#### Group Name

The name of the encoder group.

#### Enable Encoder Groups

Click this toggle switch to enable (green) or disable encoder groups for the stream.

#### Active

Indicates if the encoder group is active. If active, this indicator will be green.

#### Trigger

Click this drop-down list to select the trigger type: **manual** or **input connected**.

#### ACTIVATE

Click this button to activate the encoder group.

#### ADD

Click this button to add the IP address of an encoder to the encoder group.

## Network page

The **Network** page provides the ability to enable or disable DHCP mode for each video channel. When DHCP mode is disabled, the IP address, subnet mask, and gateway must be provided. This screen is identical to the **Network** page for the decoder.

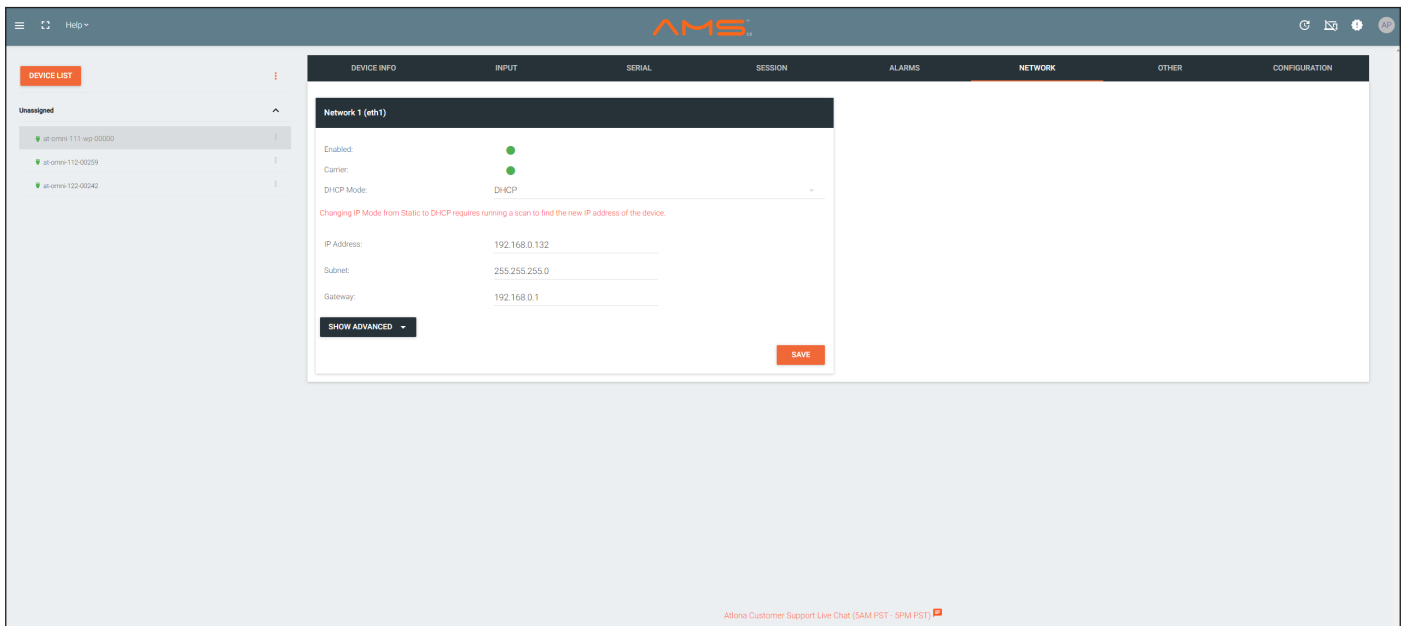

### Enabled

This indicator displays whether or not the video stream for this channel is active. If the indicator is green, then the video stream is active.

### Carrier

If this indicator is green, then an active link exists. Otherwise, if no link exists, this indicator will be red.

### DHCP Mode

Click this drop-down list to select the desired network mode. Select DHCP to let the DHCP server (if present) assign the encoder the IP settings; **Subnet** and **Gateway** fields will automatically be populated. When **Static** mode is selected, the information for the **IP Address**, **Subnet**, and **Gateway** fields must be entered.

### IP Address

Displays the IP address used by the channel. This field can only be changed if **Static** mode is selected.

### Subnet

Displays the subnet mask for the channel. This field can only be changed if **Static** mode is selected.

### Gateway

Displays the gateway (router) address for the channel. This field can only be changed if **Static** mode is selected.

### Advanced Settings

Click the **SHOW ADVANCED** button to view the following options.

#### Link Speed

Displays the port speed in Mbps.

#### MAC Address

The MAC address of the Ethernet channel.

#### Telnet Authentication

Click this toggle switch to enable or disable Telnet authentication. If enabled, then the toggle switch will be green. Once enabled, connecting to the encoder using Telnet will require login credentials. The default credentials are:

Username: admin  
Password: Atlona

#### 802.1x Mode

Click this drop-down list to select the desired authentication mode. Refer to [802.1X Authentication \(page 26\)](#) for more information.

## Other page

The **Other** page provides logo/slate, text, and PTP management. Click the menu in the upper-left corner of the AMS screen to switch between **Logo**, **Text**, and **PTP** screens.

### Logo

The **Logo** page provides the ability to upload a custom logo. This logo will be displayed when no video signal is detected. Separate logos can be uploaded: one for each channel. Refer to [Slate / Logo Insertion \(page 40\)](#) for more information on these settings.

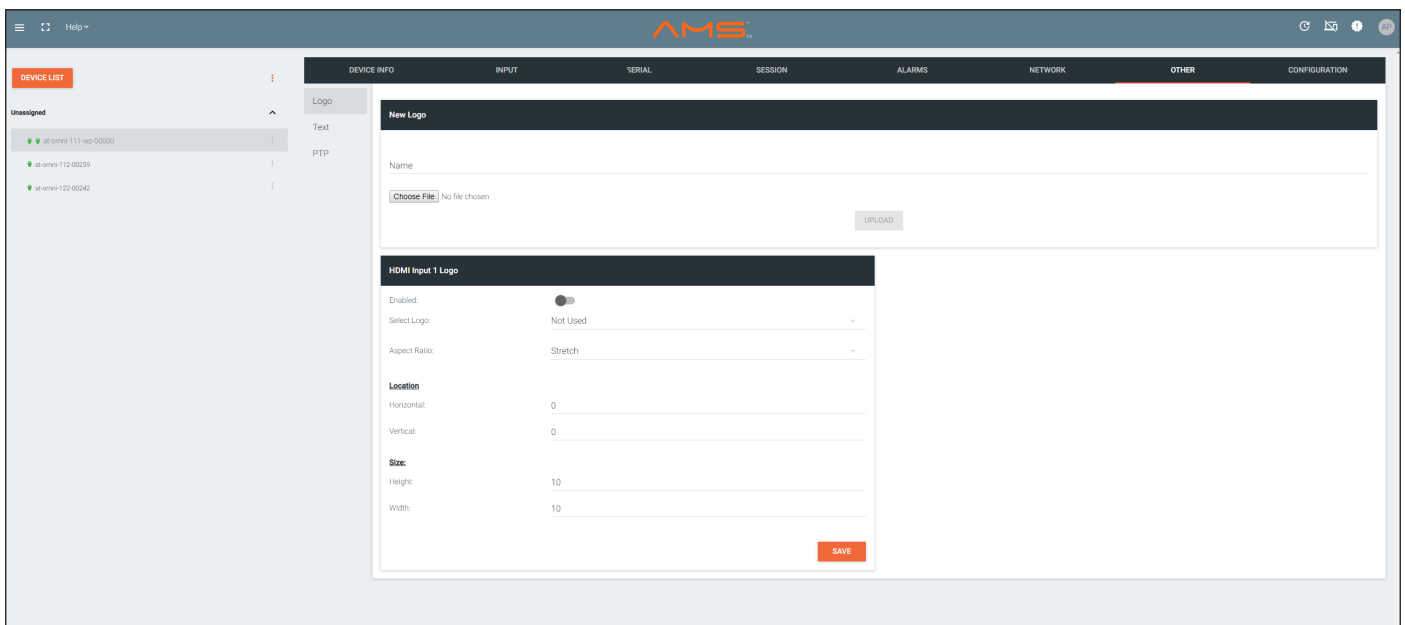

#### Name

Enter a name for the logo in this field.

#### Choose File

Click this button to select the logo file to be uploaded. Files must be in .png format and must not exceed 5 MB (5120000 bytes) in size. When an image file is uploaded, it will appear in the **Logo** drop-down list.

#### UPLOAD

Click this button to upload the logo file to the encoder.

#### Enabled

Click the toggle switch to enable or disable the logo. If the toggle switch is green, then the logo will be enabled.

#### Target

The name used by AMS to identify the encoder.

#### Select Logo

Click this drop-down list to select the desired logo. To disable the use of a logo, set to **Not Used**.

#### Aspect Ratio

Click this drop-down list to select the type of aspect ratio to be applied to the logo.

#### Horizontal

Enter the horizontal position of the logo on the screen.



## Vertical

Enter the vertical position of the logo on the screen.

## Height

Enter the horizontal resolution of the logo, in pixels.

## Width

Enter the vertical resolution of the logo, in pixels.



**IMPORTANT:** Maximum logo resolution (both height and width) is 1/4 of the video resolution.

## Text

The **Text** page provides the ability to display scrolling or stationary text superimposed on the source image. Refer to [Text Insertion \(page 44\)](#) for more information.

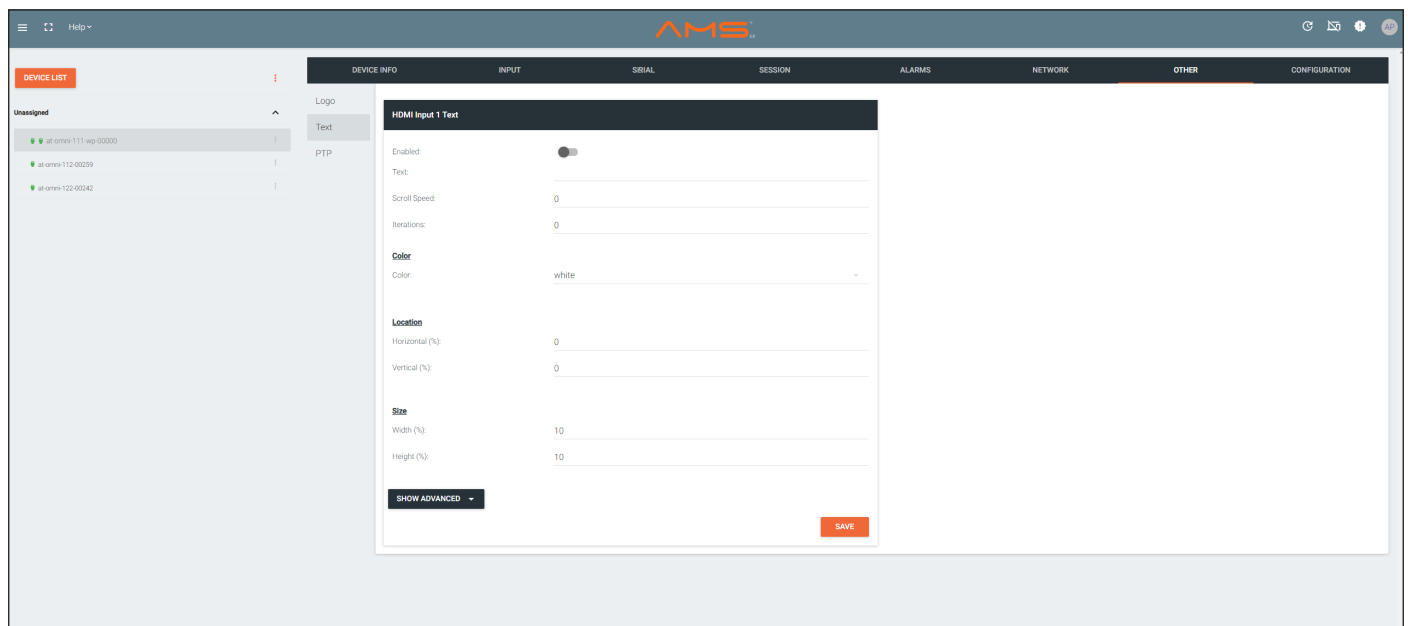

## Enabled

Click this toggle switch to enable or disable the text. When the toggle switch is green, the text will be enabled.

## Text

Enter the desired text in this field.

## Scroll Speed

Enter the scrolling speed in this field. Values from -255 to 255 are valid. Negative numbers will scroll the text from left to right. Positive numbers will scroll text from right to left.

## Iterations

Enter the number of iterations in the **Iteration** field. Set this field to 0 (zero) to set the number of iterations to infinity.

## Color

Click this drop-down list to select a solid color preset: **red, green, black, white, yellow, or blue.**

### Horizontal (%), Vertical (%)

Specify the location of the text in the Horizontal (%) and Vertical (%) fields. Each of these values is based on the horizontal and vertical resolution of the screen.

### Width (%), Height (%)

Specify the size of the text in the Width (%) and Height (%) fields. Each of these values is based on the horizontal and vertical resolution of the screen.

### Advanced Settings

Click the **SHOW ADVANCED** button to view the following options.

### Red, Green, Blue, Alpha

Enter the RGBA values for each of the respective fields, to specify a custom color and transparency of the text. Enter the desired value in the Alpha field to control the transparency of the text. A value of 255 is opaque and a value of 0 is transparent. Numbers from 0 to 255 are valid for each of these fields.

### PTP

The **PTP** page provides options for adjust Precision Time Protocol (PTP) for AES-67 audio streams. PTP is used by AES67 to keep all audio streams synchronized.

For a system utilizing PTP, all devices undergo an automatic self-election process to choose the interface to be used as the PTP grandmaster (GM) clock, based on the accuracy of the device's clock and the device's configured priority. A lower priority number means the unit is more likely to get selected as GM.



**IMPORTANT:** If a new device is added to the network and the GM changes, a brief outage will be experienced while all connected devices synchronize with the new clock. Because of this, Atlona recommends that one unit gets manually defined as the GM and have both **Priority 1** and **Priority 2** fields be set to 1.

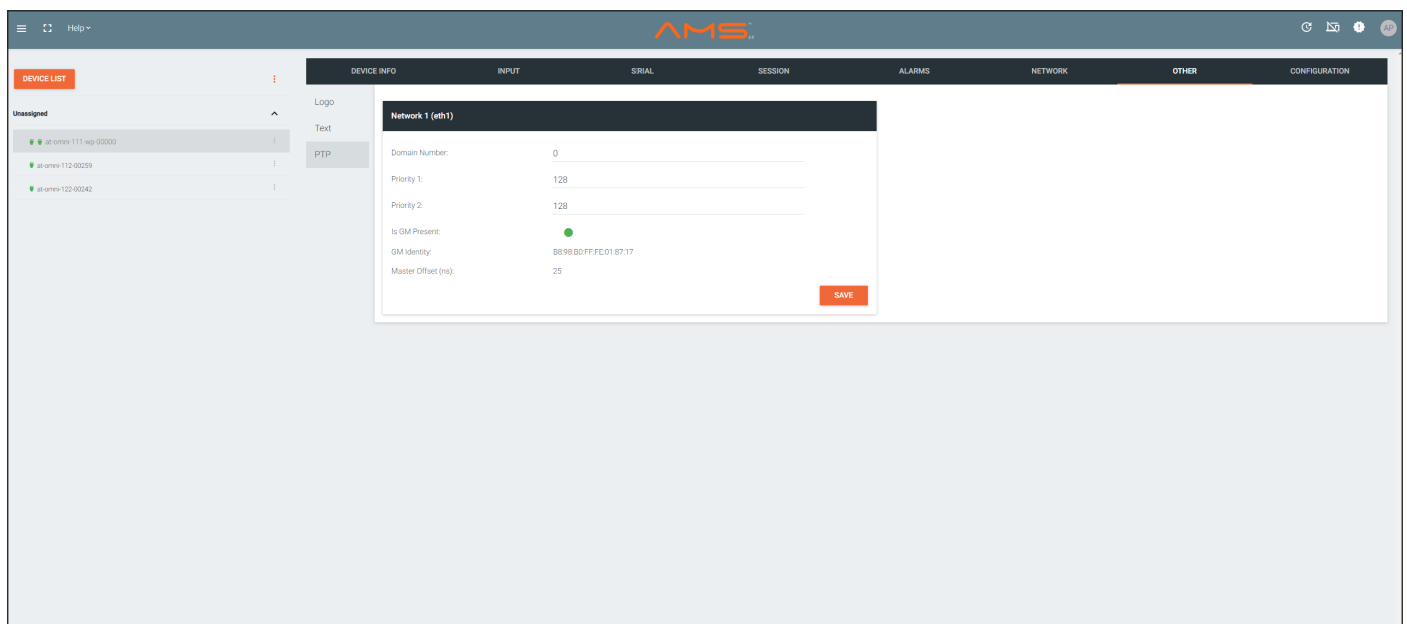

The screenshot shows the AMS interface with a navigation menu on the left containing 'DEVICE LIST', 'DEVICE INFO', 'INPUT', 'SERIAL', 'SESSION', 'ALARMS', 'NETWORK', 'OTHER', and 'CONFIGURATION'. The main content area displays the PTP configuration for 'Network 1 (eth1)'. The configuration fields are as follows:

Field	Value
Domain Number	0
Priority 1	128
Priority 2	128
Is GM Present	<input checked="" type="checkbox"/>
GM Identity	88:98:80:FF:FE:01:87:17
Master Offset (ms)	25

A 'SAVE' button is located at the bottom right of the configuration form.

**Domain Number**

Enter the domain number in this field. Valid entries are 0 through 127.

**Priority 1**

Enter the priority number in this field.

**Priority 2**

Enter the priority number in this field.

**Is GM Present**

This indicator displays the existence of a grandmaster clock for the specified PTP domain number. If the indicator is green, then the grandmaster clock exists on this interface.

**GM Identity**

The grandmaster clock identity. If this field is blank, then it means that this interface is the grandmaster clock.

**Master Offset**

Displays the grandmaster clock offset.

## The Virtual Matrix

1. Login to AMS. Refer to **Accessing Encoders in AMS** (page 12), if necessary.
2. Click the  icon, in the upper-left corner of the AMS Dashboard.
3. Click **Virtual Matrix**.

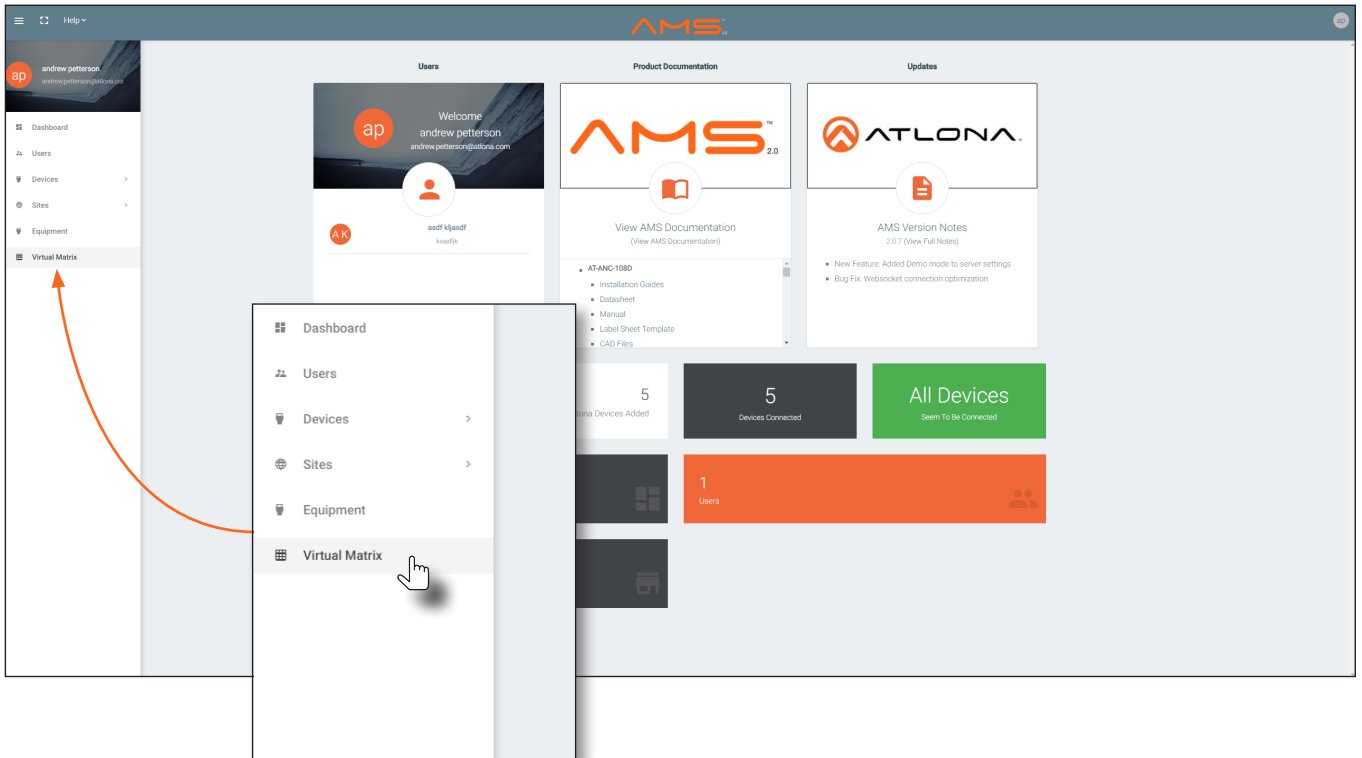

4. The **OmniStream Virtual Matrix** page will be displayed.



The screenshot displays the 'OmniStream Virtual Matrix' page. It features a table with columns for 'Encoders / Decoders' and 'LEGEND'. The table lists several AT-OMNI-112 encoders and their connections to various HDMIs (HDMI 1, HDMI 2) across different sites. The status of each connection is indicated by a green checkmark (Connected) or a blue checkmark (Options).

Encoders / Decoders	LEGEND	Andrew's AT-OMNI-112 192.168.11.181 at-omni-112-00548 Connected	AT-OMNI-121 192.168.11.134 at-omni-121-00461 Connected	AT-OMNI-122 192.168.11.85 192.168.11.87 at-omni-122-00242 Connected	AT-OMNI-521 192.168.11.29 at-omni-521-00064 Connected	AT-OMNI-122 192.168.11.160 192.168.11.161 at-omni-122-00381 Connected
AT-OMNI-112 192.168.11.89 192.168.11.88 at-omni-112-00249 Connected	HDMI 1 HDMI 2	✓ ✓	⊗ ⊗	✓ ⊗	⊗ ⊗	✓ ✓
AT-OMNI-111 192.168.11.50 at-omni-111-00200 Connected	HDMI 1	⊗	⊗	⊗	⊗	⊗
AT-OMNI-512 192.168.11.51 at-omni-512-00200 Connected	HDMI 1 HDMI 2	⊗ ⊗	✓ ⊗	✓ ✓	⊗ ⊗	⊗ ⊗
Andrew's AT-OMNI-112 192.168.11.180 at-omni-112-00272 Connected	HDMI 1 HDMI 2	✓ ✓	⊗ ⊗	✓ ✓	⊗ ⊗	✓ ✓
AT-OMNI-112 192.168.11.183 192.168.11.148 at-omni-112-00209 Connected	HDMI 1 HDMI 2	✓ ✓	⊗ ⊗	✓ ✓	⊗ ⊗	✓ ✓

## Layout and Operation

The illustration below, shows a multiple OmniStream units (encoders and decoders). The Virtual Matrix is organized into rows and columns.

The blue circle with the checkmark indicates that these two OmniStream units are connected to one another. The second column identifies a dual-channel decoder (AT-OMNI-122). The third row shows a dual-channel encoder (AT-OMNI-112). In this example, the source signal on **HDMI 1 IN** (encoder) is being sent out, over the network, and will be displayed on **HDMI 1** on the decoder. This will create a *cross-connection*, which connects both the encoder and decoder together.

- **Creating a cross-connection**

To route an input on an encoder to an output, locate the row and column where an input and output intersect, then click the square with the dots around it.

- **Removing a cross-connection**





To remove a *cross-connection*, click on the desired circle icon with the check mark symbol. The square with the dots around it will be displayed indicating that the *cross-connection* has been removed.

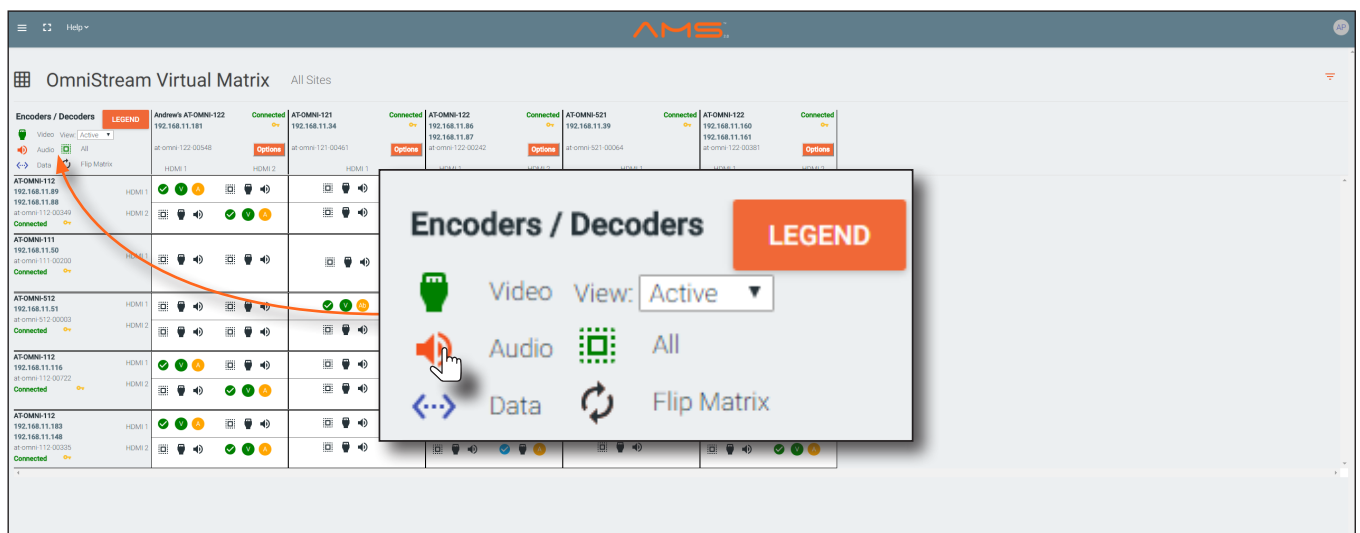

- To view the individual streams for video, audio, and data, click the icons on the upper-left corner of the screen.



When these icons are clicked, the associated icons will be displayed in the rows and columns of the Virtual Matrix.

Symbol	Description
	Video only
	Audio only
	Data only
	Connected; not all signals are active
	Connected; all streams are being used

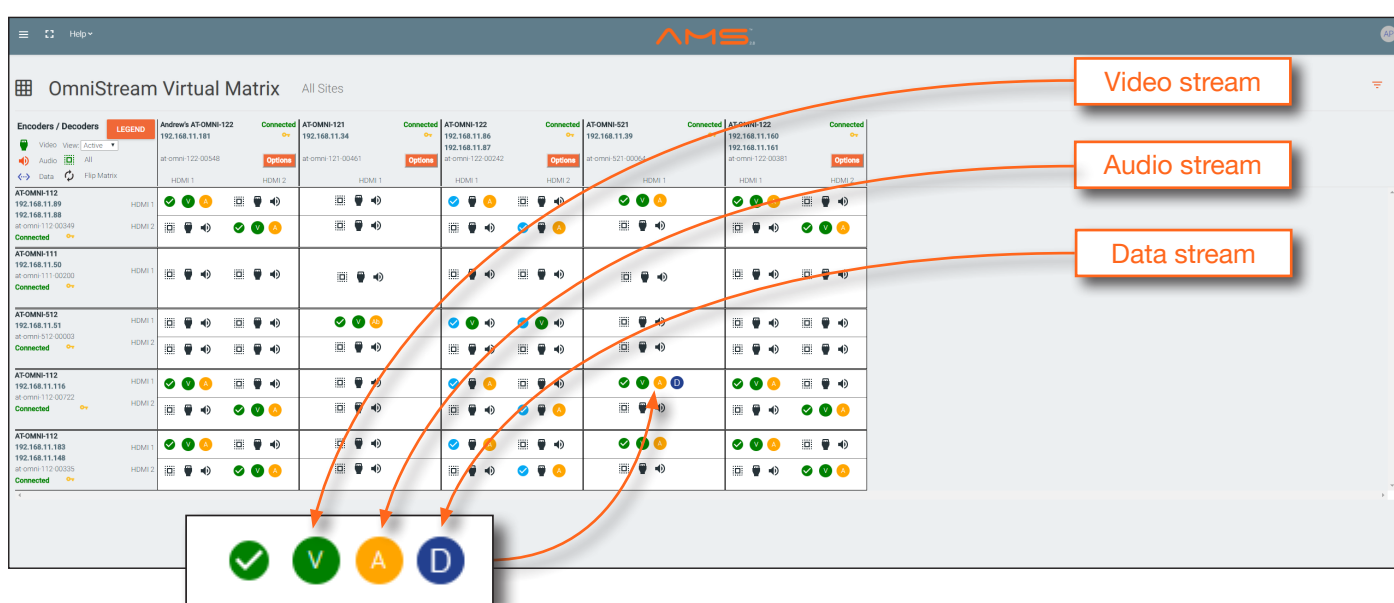

**IMPORTANT:** R-Type and Pro compatibility: R-Type encoders (AT-OMNI-512) and decoders (AT-OMNI-521) operate in Video Mode, only. Pro encoders can be set to either Video Mode or PC Mode. Video Mode is incompatible with PC Mode. Therefore, in order for both R-Type and Pro encoders/decoders to work within a system, Pro encoders/decoders must be set to Video Mode. Refer to [Setting the Video Mode \(page 39\)](#) for more information.

- Click the **Video**, **Audio**, and **Data** icons to return to the normal view.
- Since only HDMI (both audio and video) is being used, the V (video) and A (audio) icons are displayed. The blue circle with the checkmark indicates that the cross-section has been created. However, not all streams are being used. Refer to the chart below.
- This illustration also shows that the data stream (the icon with two arrows and three dots), which is used for control, is also being used and is displayed as a dark-blue circle with the letter “D”.
- The icons in the upper-left corner can also act as a filter. This allows for a clear breakdown of where signals are being routed and is useful when several encoders and decoders are used on a network.

# Appendix

## Updating the Firmware

**IMPORTANT:**



- If updating from version 1.0.x, OmniStream units must first be updated to version 1.1. Note that this does *not* apply to OmniStream R-Type units. If running version 1.0.x, contact an Atlona Technical Support Engineer before updating the firmware.
- When updating the firmware, make sure that the unit does not lose power. The firmware update process should take approximately 1 to 2 minutes.
- For full functionality of OMNI 1.2.1 (or later), Velocity must be running at least 1.4.5 and AMS must be on firmware version 2.0.12 and above.

1. Click **DEVICE INFO** in the menu bar.
2. Click the **UPDATE FIRMWARE** button to display the **Firmware Update** dialog.

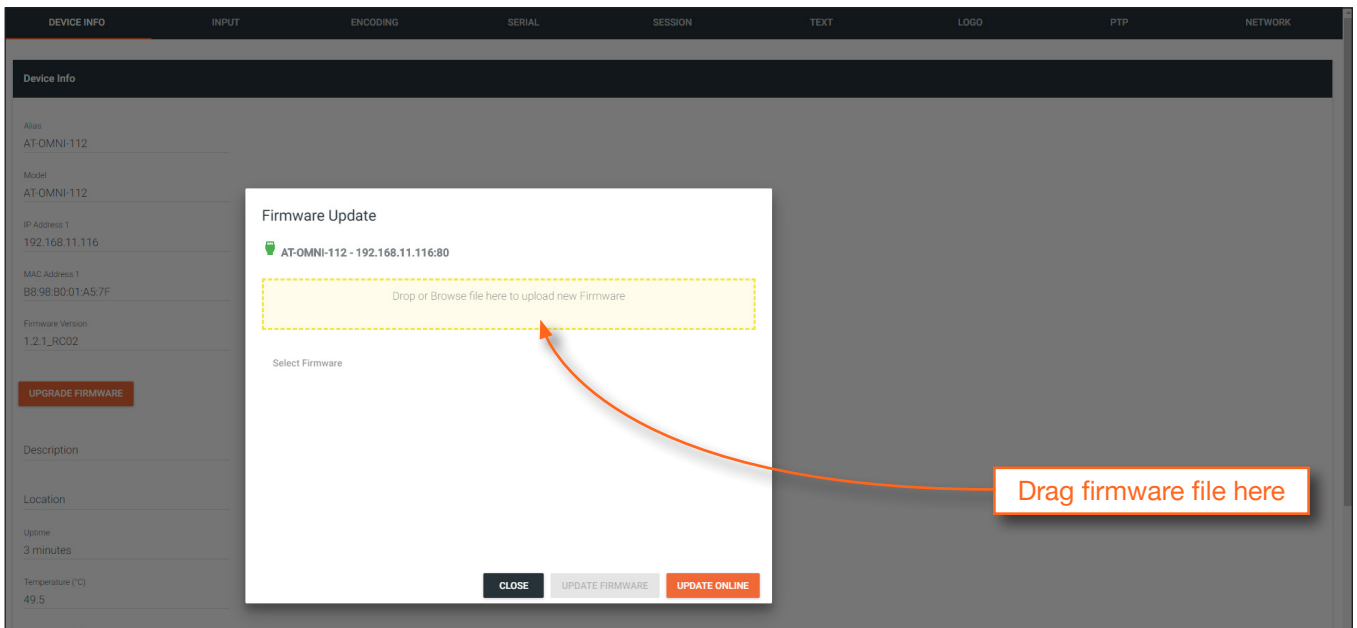

3. Click and drag the firmware file to the yellow box, to upload the firmware to the device. OmniStream firmware files use the .v2pup file extension. Once the firmware file has been uploaded, it will appear under the **Select Firmware** section of the dialog box.
4. Click the **UPDATE FIRMWARE** button to begin the update process.

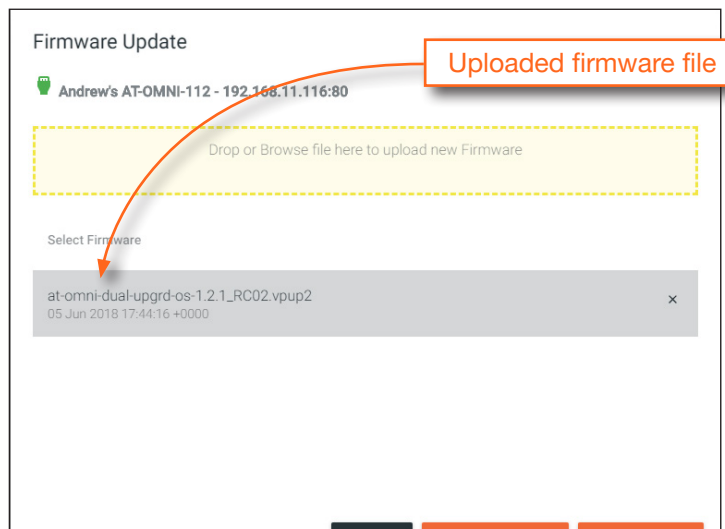

- After the **UPDATE FIRMWARE** button is clicked, the Upgrade Firmware Started message box will be displayed.

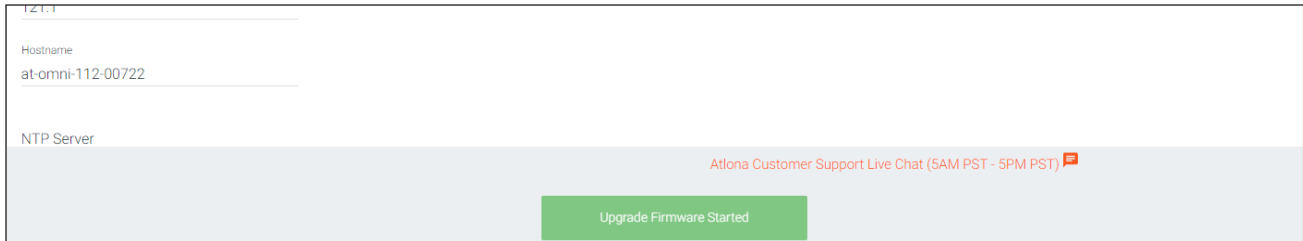

- Click the orange up-arrow icon, in the upper-right corner of the screen, as shown below. If this icon is orange, it indicates that a firmware update is in progress.

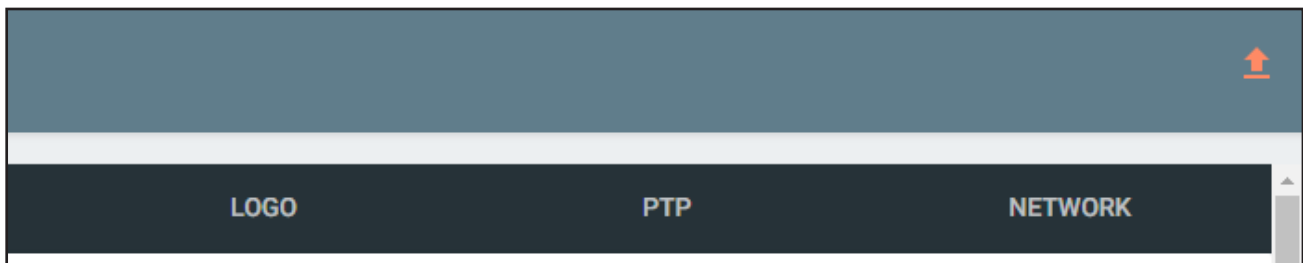

The progress bar for the update process will be displayed. The update process should take a few seconds.

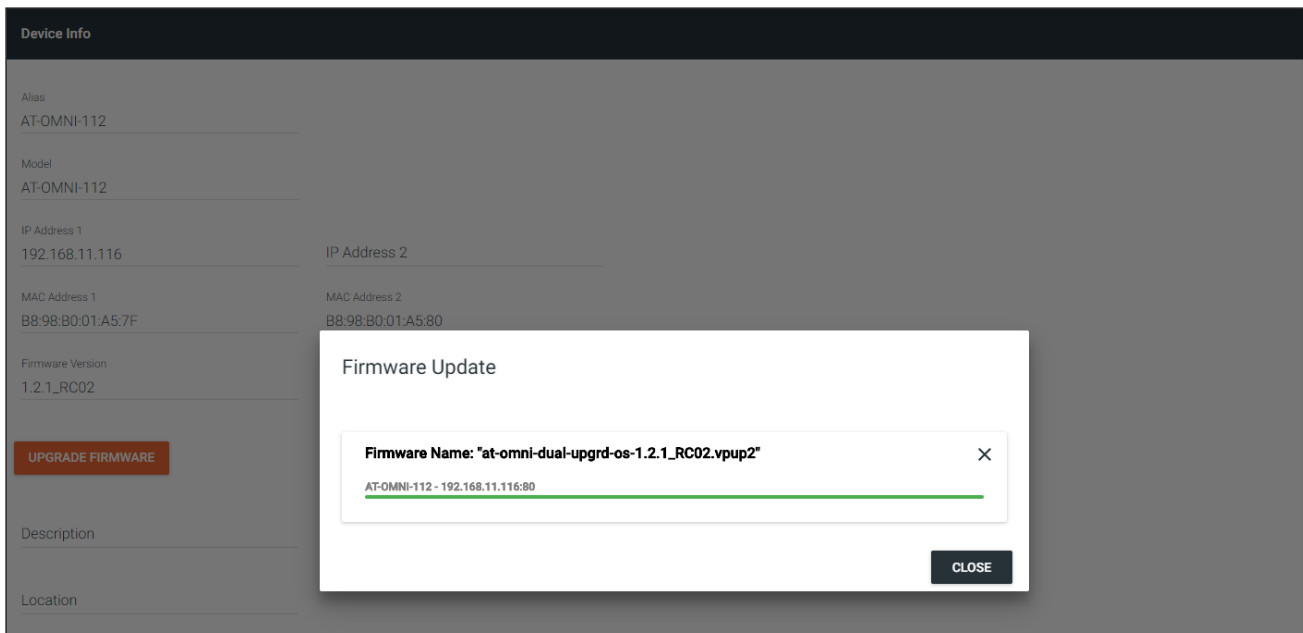

- Click the "X" to close out the progress bar window, then click the **CLOSE** button to dismiss the **Firmware Update** message box.
- The firmware update process is complete.
- Clear the web browser cache and refresh the web page. The new firmware version will appear in the **Firmware Version** field, in the **DEVICE INFO** page.



## FEC Details

### Matrix Size, Overhead, and Latency

- FEC can only work if a single packet from each row/column is missing. Multiple packets missing from each row/column will cause FEC to fail.
- Due to the above, a smaller matrix is more robust, as there is a better chance of errors not occurring in the same row/column.
- FEC has a bitrate overhead that is inversely proportional to the matrix size: the bigger the matrix, the less bitrate overhead is generated.
- FEC has a latency overhead that is directly proportional to the matrix size: the bigger the matrix, the more latency is introduced.
  - » As of v1.0.0, OmniStream does not explicitly synchronize audio and video. Therefore, FEC configuration can have a noticeable impact on lip sync. The tables below should be used to keep the audio/video lip sync as tight as possible.
- FEC latency overhead is also inversely proportional to bitrate: the higher the bitrate, the less FEC latency is introduced.
  - » For applications where lip sync is very critical, using a higher audio sampling rate, and thus a higher audio bitrate, can result in more accurate lip sync.

### FEC and Video Bitrate

- The bitrate configured on the video encoder includes FEC overhead and will automatically adjust itself depending on the bitrate needed for FEC.
- FEC overhead can be calculated using the following formulas:

$$\text{Video rate} = \frac{\text{Configured bit rate}}{1 + \left( \frac{\text{Rows} + \text{Columns}}{\text{Rows} \times \text{Columns}} \right)} \qquad \text{FEC rate} = \text{Configured bit rate} - \text{Video rate}$$

- The following table provides a few examples of how this works.

FEC / matrix usage	Configured bit rate	Used for video	Used for FEC
FEC disabled	900 Mbps	900 Mbps	0 Mbps
FEC enabled, 4x4	900 Mbps	600 Mbps	300 Mbps
FEC enabled, 10x10	900 Mbps	750 Mbps	150 Mbps
FEC enabled, 20x20	900 Mbps	818 Mbps	82 Mbps
FEC enabled, 4x4	450 Mbps	300 Mbps	150 Mbps
FEC enabled, 10x10	450 Mbps	375 Mbps	75 Mbps
FEC enabled, 20x20	450 Mbps	409 Mbps	41 Mbps

### FEC, Latency, and Lip Sync

- In order for FEC to work, the matrix must be filled in order to calculate the FEC packets. This introduces some additional latency. Due to high bitrates, this is not noticeable for video, but can be very significant for audio. Therefore, Atlona recommends either leaving FEC disabled for audio or using a very small matrix.
- Latency calculations are complex. The tables below provide some common working benchmarks. In order to minimize lip sync issues, try to match the additional latencies for video and audio as closely as possible.
  - » Video - additional video latency for enabling FEC using various matrix sizes.

Configured bit rate	4x4	10x10	20x20
900 Mbps	0.64 ms	3.20 ms	11.74 ms
450 Mbps	1.28 ms	6.40 ms	23.47 ms

- » Audio - additional audio latency for enabling FEC using various matrix sizes.

Format	1x4	2x4	4x4	10x10
2 channel PCM, 44.1 kHz	34.01 ms	68.03 ms	136.10 ms	850.30 ms
2 channel PCM, 48 kHz	31.25 ms	62.50 ms	125.00 ms	781.30 ms
2 channel PCM, 96 kHz	15.63 ms	31.25 ms	62.50 ms	390.60 ms
2 channel PCM, 192 kHz	7.81 ms	15.63 ms	31.25 ms	195.30 ms

- It is recommended to keep lip sync within  $\pm 1$  frame of video to prevent any noticeable syncing issues.
- Examples of good choices to minimize lip sync issues are:
  - » Video configured for 450 Mbps, FEC 10x10; Audio is 2 channel PCM, 192 kHz, FEC 1x4: 6.40 ms – 7.81 ms = -1.41 ms
  - » Video configured for 900 Mbps, FEC 10x10; Audio is 2 channel PCM, 48 kHz, FEC disabled: 6.40 ms – 0 ms = 6.40 ms

## Specifications

Video	
HDMI Specification	HDMI 2.0, HDCP 1.4 / 2.2
UHD/HD	4096x2160(DCI)@60/30/24 Hz, 3840x2160(UHD)@60 <sup>(1)</sup> /50/24/25/30 Hz, 1080p@23.98/24/25/29.97/30/50/59.94/60 Hz, 1080i <sup>(2)</sup> @25/29.97/30 Hz, 720p@30/50/59.94/60 Hz
VESA <sup>(3)</sup>	1920x1200, 1680x1050, 1600x1200, 1600x900, 1440x900, 1400x1050, 1366x768, 1360x768, 1280x1024, 1280x800, 1280x768, 1152x768, 1024x768
Color Space	YUV, RGB

Encoding	
Density	One encoding engine
Compression Format	VC-2 (SMPTE-2042)
Chroma Subsampling	4:4:4, 4:2:2, 4:2:0
Video Quality Optimization	User-selectable: Computer Graphics or Motion Video
Color Depth	8-bit, 10-bit, 12-bit
HDR	HDR10, HLG, Dolby Vision <sup>(4)</sup>
Bit Rate	Configurable up to 900 Mbps
Latency	0.5 frame (e.g. 1080p @ 60 Hz latency is < 8 ms between encoder and decoder) 1.5 frames in Fast Switching mode (e.g. 1080p @ 60 Hz latency is < 24 ms between encoder and decoder) Note: Unusual network configurations may increase overall latency

Audio	
Pass-through	LPCM 2.0, LPCM 5.1, LPCM 7.1, Dolby® Digital, Dolby Digital Plus, Dolby TrueHD, Dolby Atmos®, DTS®, DTS-HD Master Audio™
Down-mixing	Multichannel LPCM to two-channel LPCM
Sample Rate	32 kHz, 44.1k Hz, 48 kHz, 88.2 kHz, 96 kHz, 176.4 kHz, 192 kHz
Bit Depth	Up to 24-bit

Protocols	
Streaming	RTP
Addressing	DHCP, static
Encryption	AES-128
QoS Tagging	RFC 2475
Management	HTTPS, SSH, Telnet, and WebSockets with TLS
Authentication	IEEE 802.1x: PEAP/MSCHAPv2 or EAP-TLS

Graphics Features	
Text Insertion	Adjustable height/width, scrolling (speed, direction, or static), iterations (up to infinite), positioning, and adjustable color and alpha (transparency) channels.
Slate / Logo Insertion	PNG file format, adjustable aspect ratio (keep or stretch), horizontal/vertical size, screen position; slate mode can be set to off, manual (image always displayed, superimposed on the source signal, and will remain if source signal is lost), auto (image will only be displayed when source signal is lost).

Connectors	
HDMI	1 - Type A, 19-pin, female, locking
ETHERNET <sup>(5)</sup>	1 - RJ45, 10/100/1000 Mbps

Indicators and Controls	
PWR	1 - LED, tricolor (red, amber, green)
HDMI	1 - LED, bicolor (red, green)
LINK	1 - LED, bicolor (red, green)
Reboot	1 - momentary, tact-type

Power	
PoE	IEEE 802.3af
Consumption	Up to 12.5 W
Safety	CE, FCC, cULus, RoHS, RCM

Environmental	
Operating Temperature	+14 to +122 °F -10 to +50 °C
Storage Temperature	-14 to +140 °F -10 to +60 °C
Operating Humidity (RH)	20% to 95%, non-condensing

Chassis	
Dimensions (H x W x D)	4.19 in x 3.46 in x 1.72 in 106.5 mm x 88 mm x 43.65 mm
Weight	0.46 lbs 0.21 kg
Safety	CE, RoHS, FCC

- (1) UHDp60 only supports 4:2:0.
- (2) Scaling and deinterlacing is not supported at 1080i.
- (3) All VESA resolutions are 60 Hz.
- (4) Dolby Vision requires a separate license.
- (5) Maximum distance per hop 300 ft (100 m), depending upon network configuration.

